



**PCT2785**  
**Touch LED LCD Monitor**

**USER'S GUIDE**

[www.planar.com](http://www.planar.com)

# Content

Operation Instructions.....	1
Unpacking Instructions .....	3
Safety Precautions .....	3
Consignes de sécurité.....	4
Package Overview .....	5
Front View of the Product .....	6
Rear View of the Product .....	7
Quick Installation .....	8
Webcam Installation.....	9
Basic Operation and Calibration/Reset Instructions.....	10
Advanced Operation—OSD Menu.....	12
Supporting Timing Modes .....	15
Technical Information.....	16
Wall-Mount Installation Instructions.....	17
Troubleshooting.....	18
Planar Support .....	19

## Operation Instructions

Thank you for purchasing the PCT2785 multi-touch, edge-lit LED LCD monitor. Please read this guide thoroughly before installation.

### **FCC RADIO FREQUENCY INTERFERENCE STATEMENT WARNING: (FOR FCC CERTIFIED MODELS)**

This LED Monitor has been tested and found compliant with the limits for a Class B digital device, pursuant to part 15 of the FCC Rules. These limits are designed to provide proper protection against harmful interference to a residential installation. This Touch LED LCD Monitor generates, uses, and can radiate radio frequency energy. Harmful interference to radio communication may be the result if it's not properly installed and used. However, there is no guarantee that interference will not occur in a particular installation. If this Touch LED LCD Monitor does cause serious interference to radio or television reception, resetting may correct it. Moreover, users are encouraged to reduce interference by doing one or more of the following:

- Reorient or relocate the receiving antenna.
- Move the Touch LED LCD Monitor and the receiver further away from each other.
- Connect the Touch LED LCD Monitor into an outlet on a circuit different from that to which the receiver is connected.
- Consult your local dealer or a qualified technician.

### **FCC Warning:**

To assure a continued FCC compliance, a user must use a grounded power supply cord and the provided shielded video interface cable with bonded ferrite cores. Also, any unauthorized changes or modifications to this Touch LED LCD Monitor would void the user's authority to operate this device.

**Note:** If necessary, shielded interface cables and AC power cord must be used to meet the emission level limits.



According to WEEE regulation, this Touch LED LCD Monitor can't be handled as normal trash in Europe when it is out of usage. Please refer to the recycle information on Planar's website to handle it.

For more information on how to recycle your product, please visit <http://www.planar.com/about/green/>

## **COMMUNIQUE D'AVERTISSEMENT DE LA FCC CONCERNANT LES INTERFERENCE DE FREQUENCE RADIO: (SEULEMENT POUR MODELES CERTIFIE PAR LA FCC)**

Ce moniteur a été testé et a été trouvé conforme aux limites pour un appareil numérique de Classe B, suivant la partie 15 des règlements de la FCC. Ces limites ont été développées pour offrir une protection satisfaisante contre les interférences nuisibles dans une installation résidentielle. Ce moniteur génère, utilise et peut radier de l'énergie de fréquence radio. Ceci peut causer des interférences nuisibles à des communication radio si l'appareil n'est pas convenablement installé et utilisé. Il n'y a néanmoins aucune garantie que des interférences n'apparaîtront pas dans une installation particulière. Si ce moniteur cause de sérieuses interférences à la réception de signaux radios ou télévisées, une possibilité est de réinitialiser le moniteur. Les usagers sont aussi encouragés à corriger les interférences en appliquant une ou plusieurs des démarches suivantes:

- Réorientez ou déplacez l'antenne de réception.
- Placez le moniteur et le récepteur plus loin l'un de l'autre.
- Connectez le moniteur à une prise différente de celle à laquelle le récepteur est connecté.
- Consultez votre revendeur local ou un technicien qualifié.

### **Avertissement de la FCC:**

Pour assurer une conformité continue au règlements de la FCC, l'utilisateur doit utiliser un cordon d'alimentation mis à terre et le câble d'interface vidéo protégé avec noyaux en ferrite, fourni avec l'appareil. Chaque modification ou changement non-autorisé appliqué à ce moniteur peut faire perdre à l'utilisateur son droit d'opération de cet appareil.

**Note:** Si nécessaire, des câbles d'interface protégés et un cordon d'alimentation alternante doivent être utilisés pour être conforme aux limites d'émission.

## Unpacking Instructions

- Remove the Touch LED LCD Monitor out of the package and take off the plastic bag and Polystyrene Foam.
- Pull the base from Parallel versus Panel to Vertical.
- Adjust the Panel between 15° leaning forward and 70° leaning backward.

## Safety Precautions

Follow all warnings, precautions and maintenance as recommended in this user's manual to maximize the life of your unit.

### **Do:**

- Turn off the product before cleaning.
- Touch screen surface may be cleaned using a soft clean cloth moistened with mild window glass commercial cleaners or 50/50 mixture of water and isopropyl alcohol.
- Use a soft cloth moistened with mild detergent to clean the display housing.
- Disconnect the power plug from AC outlet if the product is not going to be used for an extended period of time.

### **Don't:**

- Do not touch the LED Display screen surface with sharp or hard objects.
- Do not use abrasive cleaners, waxes or solvents for your cleaning.
- Do not operate the product under the following conditions:
  - Over 16 hours per day.
  - Extremely hot, cold or humid environment.
  - Areas susceptible to excessive dust and dirt.
  - Near any appliance generating a strong magnetic field.
  - In direct sunlight.
- If smoke, abnormal noise or odor emits from your Touch LED LCD Monitor, remove the power cord immediately and call your service center.
- Never remove the rear cover of your Touch LED LCD Monitor. The display unit inside contains high-voltage parts and may cause electric shock.
- Never try to repair your Touch LED LCD Monitor yourself. Always call your service center or a qualified technician to fix it.
- Due to safety concerns, if the VESA mounting kit is purchased separately, please make sure the mounting kit is UL-listed, and replaceable only by service personnel.

## Consignes de sécurité

Respectez tous les avertissements, les précautions et conseils d'entretien recommandés dans ce manuel de l'utilisateur pour maximiser la durée de vie de votre appareil.

### **A faire :**

- Éteindre le produit avant de le nettoyer.
- La surface de l'écran tactile peut être nettoyée avec un chiffon doux et propre imprégné d'un nettoyant doux du commerce pour vitres ou d'un mélange à 50/50 d'alcool isopropylique et d'eau.
- Utilisez un chiffon doux imprégné d'un détergeant doux pour nettoyer le carter de l'affichage.
- Débranchez la fiche d'alimentation de la prise de courant secteur si le produit ne doit pas être utilisé pendant une période prolongée.

### **A ne pas faire :**

- Ne touchez pas la surface de l'écran LED avec des objets coupants ou durs.
- N'utilisez pas des produits de nettoyage abrasifs, de la cire ou des solvants pour le nettoyage.
- N'utilisez pas le produit dans les conditions suivantes :
  - Plus de 16 heures par jour.
  - Environnement extrêmement chaud, froid ou humide.
  - Endroits poussiéreux ou sales.
  - Près d'appareils générant un fort champ magnétique.
  - Sous la lumière directe du soleil.
- Si de la fumée, un bruit anormal ou une odeur s'échappait de votre moniteur LCD LED, débranchez immédiatement le cordon d'alimentation et appelez votre centre de réparation.
- Ne retirez jamais le couvercle arrière de votre moniteur LCD LED. L'unité d'affichage contient des éléments où circule un voltage élevé et présentant un risque d'électrocution.
- N'essayez jamais de réparer vous-même votre moniteur LCD LED. Faites toujours appel à votre centre de service ou à un technicien qualifié pour toute réparation.
- Pour des raisons de sécurité, si vous achetez séparément le kit de fixation VESA, assurez-vous que celui-ci est certifié UL, et qu'il peut être remplacé uniquement par un technicien qualifié.

## Package Overview

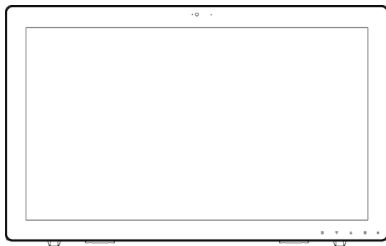

Touch LED LCD Monitor

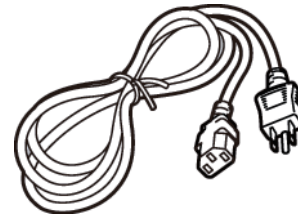

Power Cord

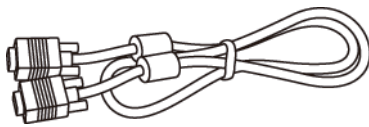

VGA Signal Cable



Audio-in Cable

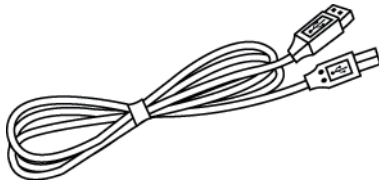

USB Cable (A to B)

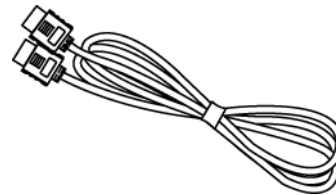

HDMI Cable

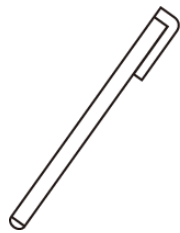

Touch Pen



Cable Wrap



User's Guide



Cleaning Cloth

## Front View of the Product

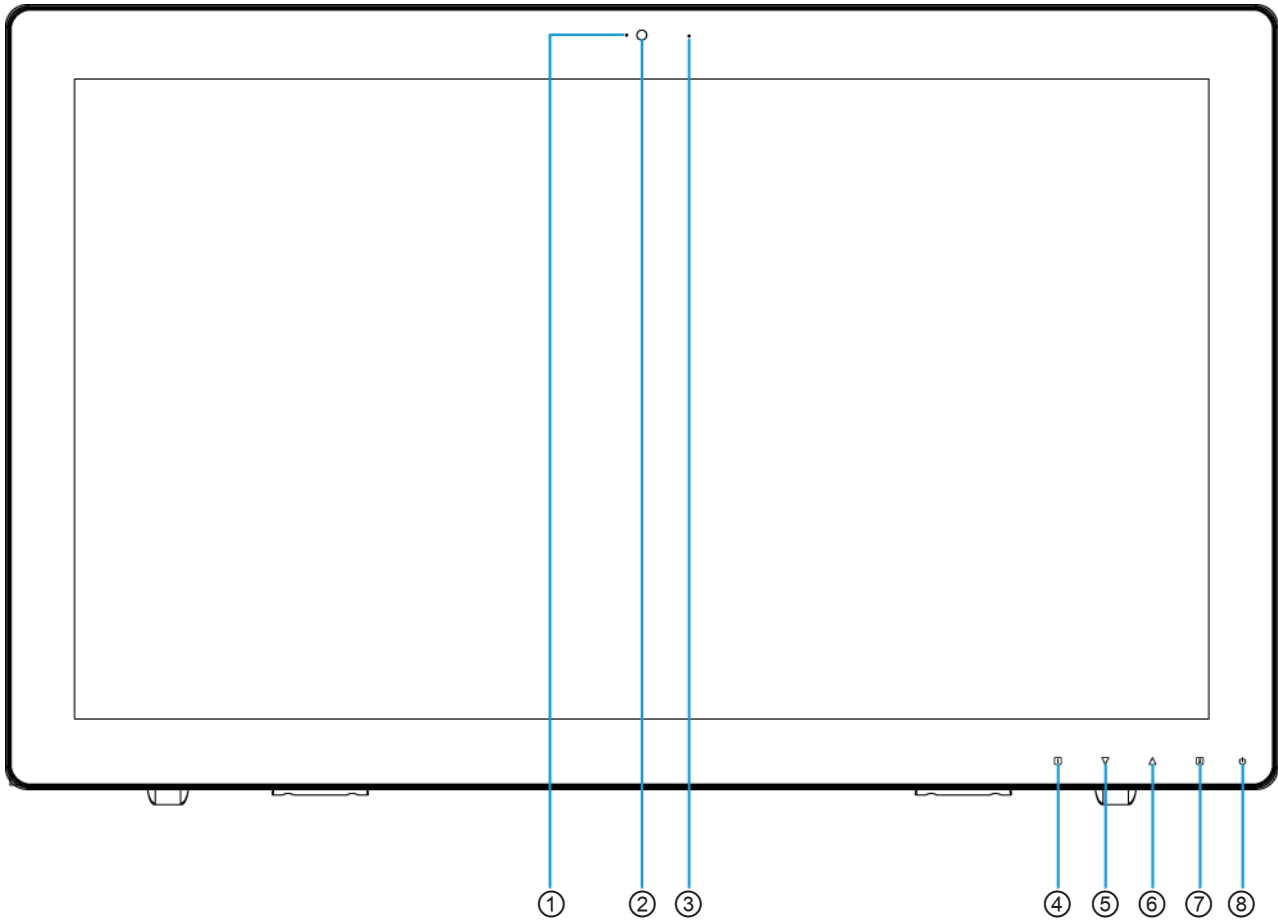

①	Webcam LED indicator
②	Webcam
③	Microphone
④	OSD Turn On/ Off
⑤	Scroll Down/ Adjust Decrease/ Brightness/ Auto *
⑥	Scroll UP/ Adjust Increase/ Blue Light Reducer *
⑦	Input select/ Confirm Selection
⑧	Power On/ Off/ LED Indicator

\* Hot keys Instructions please see "Using the OSD Menu" on page 10.



## Rear View of the Product

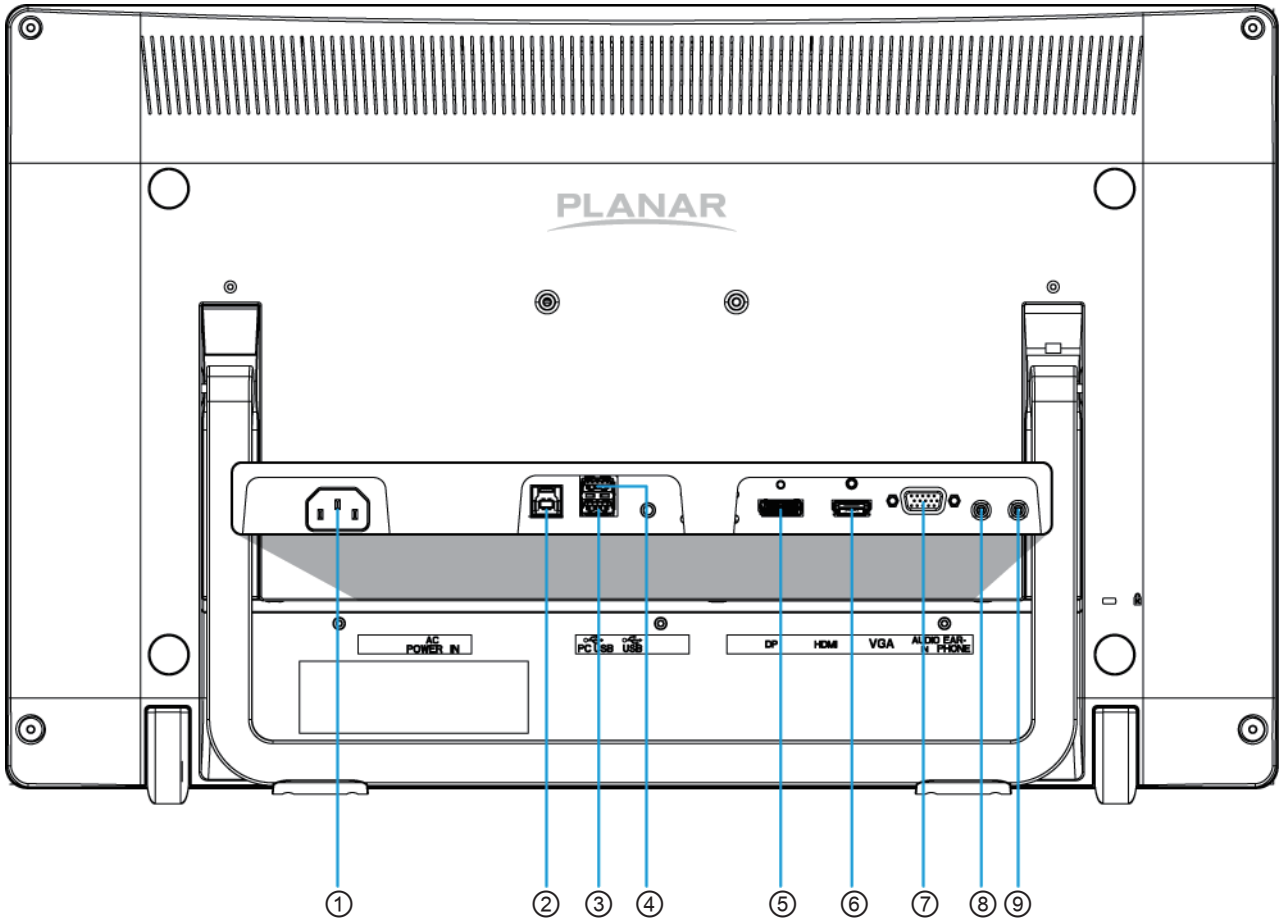

①	Power Input
②	Up-stream USB 3.0 port (to PC)
③	USB port-A (support USB 3.0 plug play device)
④	USB port-B (support USB 3.0 plug play device)
⑤	DisplayPort Input (DisplayPort 20 pin)
⑥	HDMI input (HDMI 19 pin)
⑦	VGA Input (D-Sub 15 pin)
⑧	Audio Input
⑨	Headphone Jack

## Quick Installation

1. Connect either VGA, HDMI or DisplayPort Video Source from the monitor to the computer. Make sure both monitor and computer are powered OFF. Please note. The monitor ships with only VGA and HDMI cables. DisplayPort cable may be sourced separately from a cable supplier.
2. Connect the audio cable from audio output of computer to the audio input of the monitor.
3. Connect the USB cable from the computer to the monitor.
4. Connect power cord to a properly grounded AC outlet, and then to the monitor.
5. Power-ON computer and then POWER-ON the monitor.
6. Set the timing mode on your computer. Recommended resolution and refresh rate is 1920 x 1080 @ 60Hz.

Figure 1:

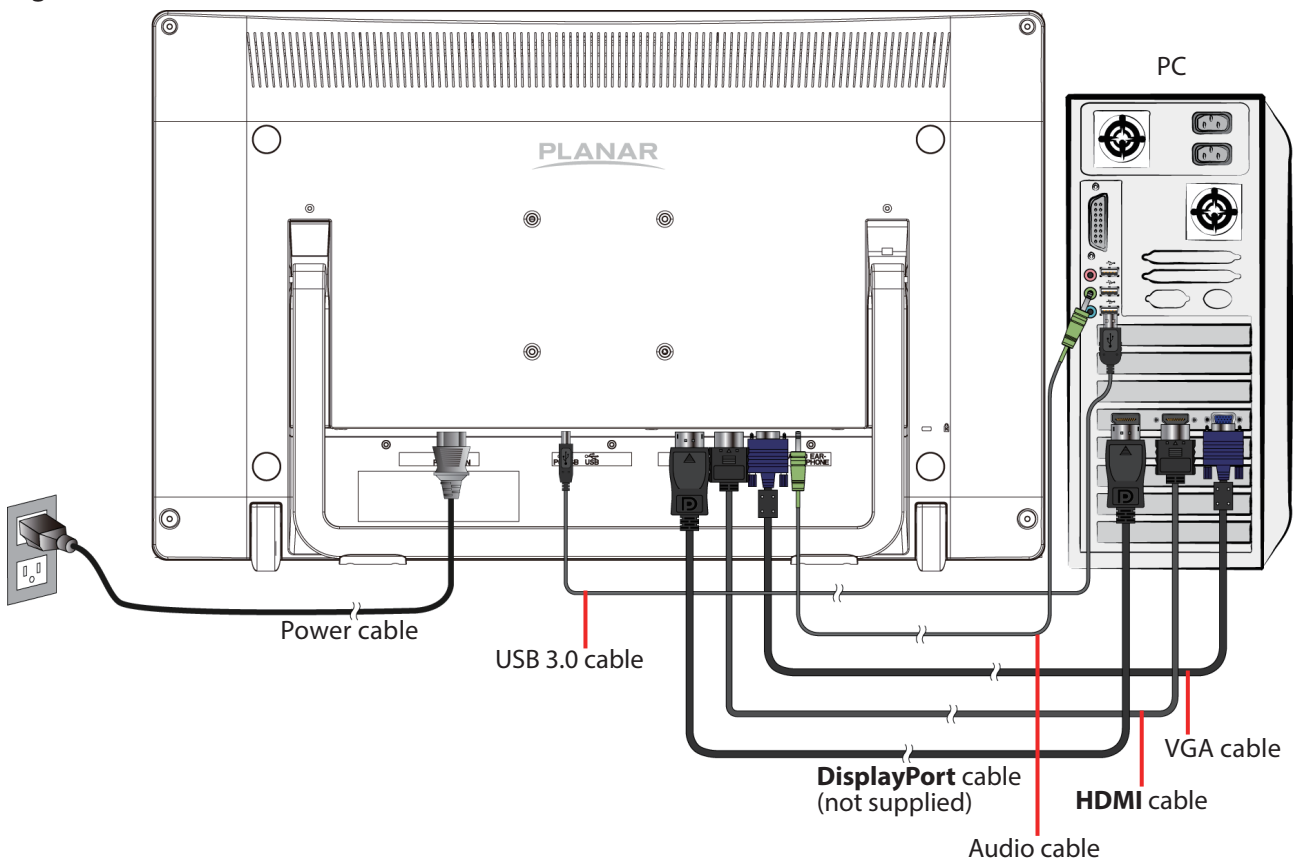

## Webcam Installation

1. Download the free “Instant messaging software” such as Yahoo Messenger, or Skype from the Internet. Complete the installation.
2. Use the USB 3.0 cable (included with the monitor) to connect the monitor to one of the USB 3.0 ports of the computer.
3. Windows will automatically search for the camera, and proceed with the installation of the driver.
4. Start the Messenger software, and enjoy the pleasure of video chat.

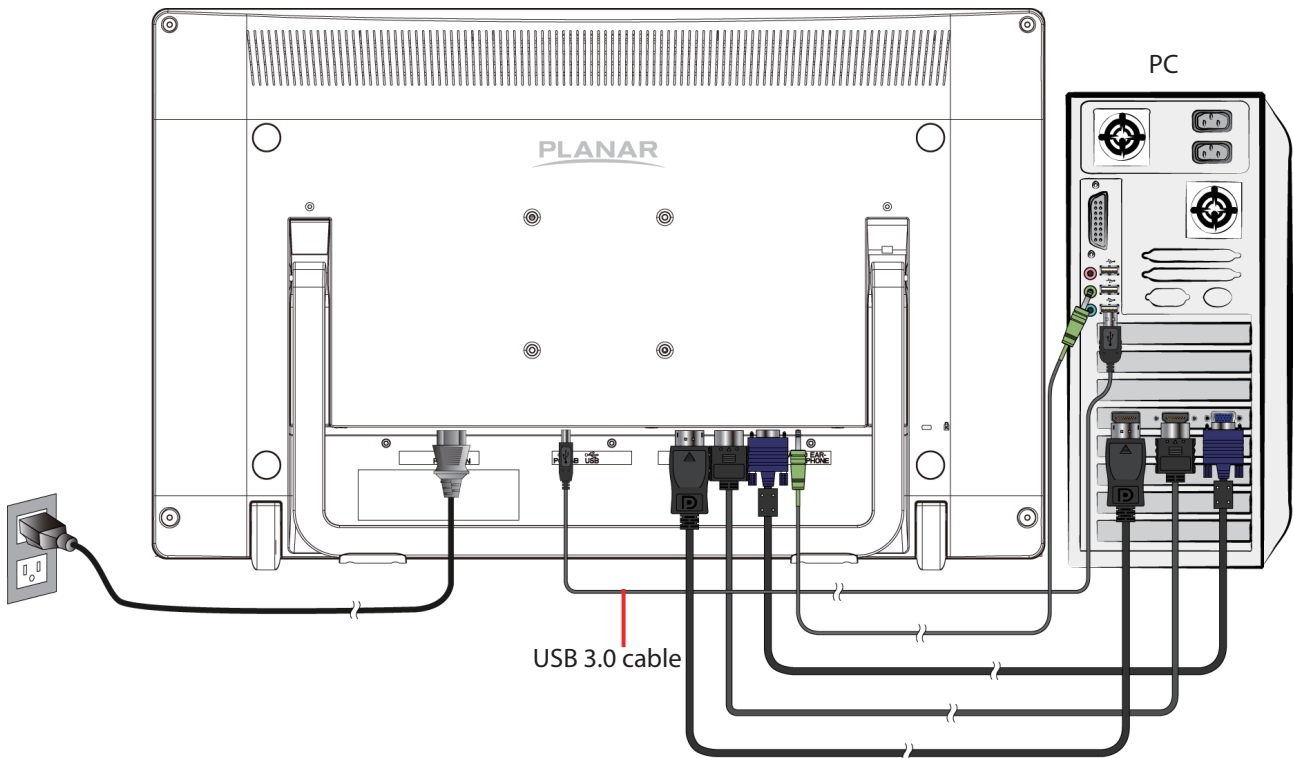

### Basic System Requirements

- Microsoft Windows 7, 8
- Pentium or compatible processor, 400 GHz
- USB Port
- Messenger Software (supporting video chat function), Video Software, or Video Conferencing System

### Hardware Installation

Connect your webcam’s USB cable to an available USB 3.0 port on your computer. Windows automatically detects the device.

## Basic Operation and Calibration/Reset Instructions

Before using the Touch LED LCD Monitor:

- Connect external equipment properly.
- Insert the power plug, and the power LED indicator will light orange.

### Power On/Off

To turn the Touch LED LCD Monitor on/off:

Press  button on the front. The power LED indicator light will be blue when the Touch LED LCD Monitor is on.

### Using the OSD Menu

Use OSD menus to adjust settings by using the menu button on the front of the Touch LED LCD Monitor.

1	Displays main menu
	Exits from OSD menu
2	Selects between VGA, HDMI, DISPLAYPORT or AUTO mode
▼	Select the desired item when in OSD menu
	When not in OSD menu, directly enters BRIGHTNESS Menu, press 3 seconds enters AUTO IMAGE ADJUST
▲	Select the desired item when in OSD menu
	When not in OSD menu, directly enters Blue Light Reducer Menu
▼ + ▲	Recalls both Contrast and Brightness (when not in OSD menu)

### OSD Lock Out Function

When Touch LED LCD Monitor is in normal mode, the “OSD Lock Out” function can be enabled.

**Option 1:** OSD lock – all 4 buttons are locked except the “POWER” button.

Press and hold the  button and the ▲ button for 3 seconds to lock the OSD buttons.

The Touch LED LCD Monitor will show an “OSD LOCKED” message for 3 seconds and the message will disappear automatically.



OSD LOCKED

Repeat this step to unlock.

**Option 2:** OSD & Power button lock – all 5 buttons including the “POWER” button are locked. Press and hold the  button and the ▼ button for 3 seconds to lock all 5 buttons.

The Touch LED LCD Monitor will show a “POWER BUTTON LOCKED” message for 3 seconds and the message will disappear automatically.



Repeat this step to unlock.

### **PCT2785 Calibration/Reset Instructions:**

The PCT2785 is available with USB connection. It is Microsoft® Windows® 7, 8 HID (Human Interface Device) compatible if you use the USB touch screen interface. No additional software driver is required. Calibration is a simple process and can be invoked by running Tablet PC Settings from Control Panel and clicking the Calibrate button.

Click the **Reset** button to reset the touchscreen to the factory calibration settings. To reset the existing calibration data, click "Reset" in the Tablet PC Settings window.

## Advanced Operation—OSD Menu

You can use the OSD menu to adjust various settings for your Touch LED LCD Monitor. Press the **1** button to display the OSD Menu, and use **▲** or **▼** to select the desired OSD menu.

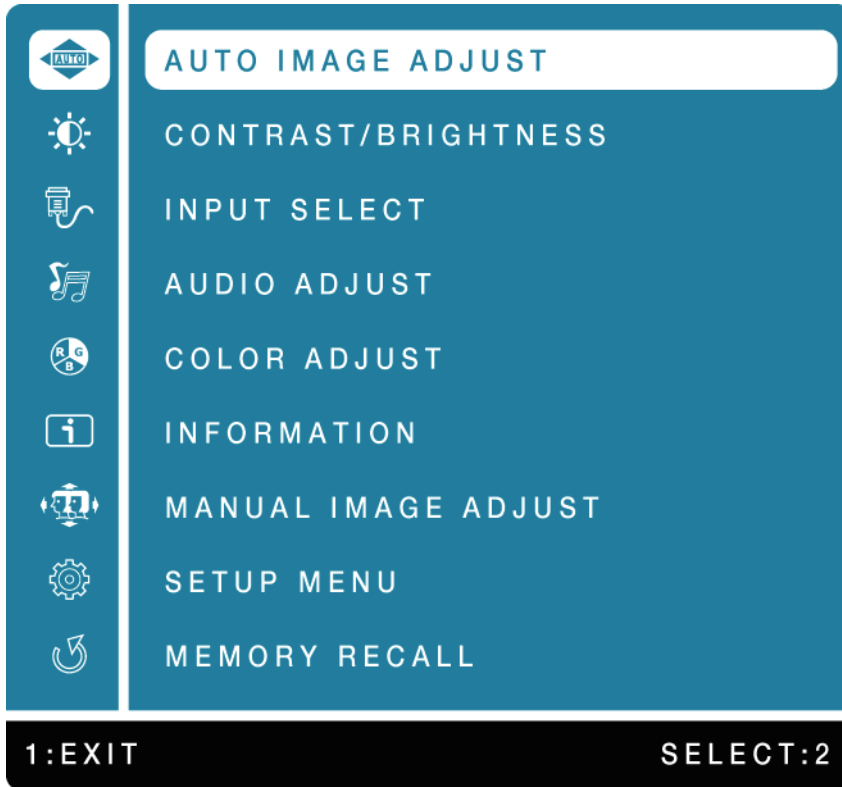

### Short Cuts Function from the button(s)



**AUTO IMAGE ADJUST:** To auto adjust Horizontal Position, Vertical Position, Phase (Fine Tune) and Clock (H. Size) of the screen.



**CONTRAST/BRIGHTNESS:** To manually adjust the CONTRAST, BRIGHTNESS, ECO MODE and OVER DRIVE of screen image.

**CONTRAST:** To adjust the foreground white level of screen image.

▲: increase contrast, ▼: decrease contrast.

**BRIGHTNESS:** To adjust the luminance of the video.

▲: increase brightness, ▼: decrease brightness.

**ECO MODE:** Allows the user to change the ECO mode. Contrast and Brightness adjustment will be disabled when ECO is active.

Press ▲ or ▼ key to adjust the ECO Mode in three levels.

**OVER DRIVE:** Allows the user to change the Over Drive strength. Improve the quality of the motion pictures.

Press ▲ or ▼ key to adjust the Over Drive strength in five levels.



**INPUT SELECT:** When Input Select is pressed, change Input signal to VGA, HDMI, DISPLAYPORT or AUTO.



**AUDIO ADJUST:** To adjust the audio functions.

**VOLUME:** To adjust the volume of speaker output.

**MUTE:** To turn the Mute ON/OFF.

**AUDIO INPUT:** When in HDMI input, select where the audio source comes from AUDIO IN or HDMI. When in DisplayPort input, select where the audio source comes from AUDIO IN or DP.



**COLOR ADJUST:** To select the color for improving brightness and color saturation between COOL, NORMAL, WARM, USER COLOR, PICTURE MODE and BLUE LIGHT REDUCER.

**COOL:** Adds blue to screen image for cooler white.

**NORMAL:** Adds red to screen image for warmer white and richer red.

**WARM:** Adds green to screen image for a darker color.

**USER COLOR:** Individual adjustments for red (R), green (G), blue (B).

1. Press button **2** to select the desired color.
2. Press ▲ or ▼ button to adjust selected color.

**PICTURE MODE:** Provides an optimum display environment depending on the contents displayed. It contains 5 user-selectable presets.

- **STANDARD** is for general windows environment and monitor default setting.
- **GAME** optimized for PC game environment.
- **CINEMA** optimized for movie and video environment.
- **SCENERY** optimized for displaying outdoor scenery images.
- **TEXT** optimized for text editing and viewing in a word processing environment.

**BLUE LIGHT REDUCER:** To decrease the blue light emitted from the display to reduce the risk of blue light exposure to your eyes. (CONTRAST, Color Temperature-COOL, NORMAL, WARM, USER COLOR and PICTURE MODE adjustment will be disabled when BLUE LIGHT REDUCER is active.)

Press ▲ or ▼ key to adjust the Blue Light Reducer strength.

- VIDEO – Ideal for watching videos (15% reduction)
- WEB BROWSING – Ideal for web browsing (30% reduction)
- READING – Ideal for reading (50% reduction)
- LOW LIGHT – Ideal for low ambient lighting environments (70% reduction)



**INFORMATION:** To display the information, regarding the current input signal coming from the graphic card in your computer.

**Note:** See your graphic card user guide for more information about changing the resolution and refresh rate.



**MANUAL IMAGE ADJUST:** To manually adjust the H. /V. POSITION, HORIZONTAL SIZE, FINE TUNE, SHARPNESS and VIDEO MODE ADJUSTMENT.

**H./V. POSITION:** To adjust the horizontal and vertical position of the video.

**HORIZONTAL POSITION:** ▲: move screen to the right, ▼: move screen to the left.

**VERTICAL POSITION:** ▲: move screen up, ▼: move screen down.

**HORIZONTAL SIZE:** To adjust the width of the screen image.

▲: increase the width of screen image, ▼: decrease the width of screen image.

**FINE TUNE:** To adjust the delay time of data and clock.

Press ▲ or ▼ to adjust to your preference.

**SHARPNESS:** To adjust the clarity of a non-Full HD Resolution (1920x1080) signal with ▲ or ▼ button.

**VIDEO MODE ADJUSTMENT:** To select the video mode from Full Screen or ASPECT RATIO.



**SETUP MENU:** To set up LANGUAGE SELECT, OSD POSITION, OSD TIME OUT, OSD BACKGROUND and LED mode.

**LANGUAGE SELECT:** To allow users to choose from available languages.

**OSD POSITION:** Press ▲ or ▼ button to select between horizontal and vertical OSD Position adjustment.

**HORIZONTAL POSITION:** To horizontally adjust the OSD position.

▲: move OSD to the right, ▼: move OSD to the left.

**VERTICAL POSITION:** To vertically adjust the OSD position.

▲: move OSD up, ▼: move OSD down.

**OSD TIME OUT:** To automatically turn off On Screen Display (OSD) after a preset period of time.

**OSD BACKGROUND:** Allows the user to turn the OSD background On or Off.

**LED:** Allows the user to turn the LED Indicator On or Off.



**MEMORY RECALL:** To recall factory settings for Video & Audio controls.

Press button **2** to select the Memory Recall menu option.



## Supporting Timing Modes

STANDARD	RESOLUTION
VGA	720 x 400 @ 70Hz
VGA	640 x 480 @ 60Hz
MAC	640 x 480 @ 67Hz
VESA	640 x 480 @ 72Hz
VESA	640 x 480 @ 75Hz
VESA	800 x 600 @ 56Hz
VESA	800 x 600 @ 60Hz
VESA	800 x 600 @ 72Hz
VESA	800 x 600 @ 75Hz
MAC	832 x 624 @ 75Hz
VESA	1024 x 768 @ 60Hz
VESA	1024 x 768 @ 70Hz
VESA	1024 x 768 @ 75Hz
VESA	1280 x 960 @ 60Hz
VESA	1152 x 864 @ 75Hz
MAC	1152 x 870 @ 75Hz
VESA	1280 x 1024 @ 60Hz
VESA	1280 x 1024 @ 75Hz
VESA	1440 x 900 @ 60Hz
VESA	1440 x 900 @ 75Hz
CVT	1400 x 1050 @ 60Hz
VESA	1600 x 1200 @ 60Hz
VESA	1680 x 1050 @ 60Hz
VESA	1920 x 1080 @ 60Hz

**Note:**

1. HDMI and DisplayPort supports 480i, 480p, 576i, 576p, 720p, 1080i, and 1080p.
2. Simultaneously press **1** and **2** keys on monitor panel to switch between similar PC timings.

**Similar PC Timing on list below:**

- 640 x 350 @ 70Hz / 640 x 400 @ 70Hz / 720 x 400 @ 70Hz
- 640 x 480 @ 60Hz / 720 x 480 @ 60Hz
- 1440 x 1050 @ 60Hz / 1680 x 1050 @ 60Hz

**Warning:** Do not set the graphic card in your computer to exceed these maximum refresh rates. Doing so may result in permanent damage to your Touch LED LCD Monitor.

## Technical Information

<b>Panel</b>	27" TFT (with LED backlight)
<b>Power Management</b>	On: 45 Watts (typical), 60 Watts (maximum) Standby Mode: < 2.4 Watt (USB 3.0) Off: < 2.4 Watt (USB 3.0)
<b>Displayable Resolution</b>	Full HD 1920 x 1080 max. Vertical Frequency 60Hz max.
<b>Pixel Dimension</b>	0.31125 x 0.31125 mm
<b>Display Color</b>	16.7M
<b>Tilt</b>	15° to 70°
<b>Active Display Area</b>	597.888 mm x 336.312 mm
<b>Temperature</b>	Operating: 0°C ~ +40°C Storage: -20°C ~ + 60°C
<b>Compliance</b>	FCC-B, CE, UL/cUL, TÜV/Bauart
<b>Power</b>	Input Voltage AC100-240 V
<b>Amplifier spec.</b>	2W x 2
<b>Web Camera</b>	HD 720p
<b>Touch Technology</b>	Multi-Touch Projective Capacitive (USB interface)
<b>Accuracy</b>	Comply to WIN10 logo requirement
<b>Glass Coating</b>	Non-coating
<b>OS</b>	Microsoft Windows 7, 8, 10

## Wall-Mount Installation Instructions

### Wall Mount Arm not included

Turn the power OFF then disconnect the cables from the Touch LED LCD Monitor before performing the procedure below.

1. Lay the Touch LED LCD Monitor face down on a soft surface.
2. Follow instructions included with the Wall Mount kit.



### NOTE

100mmx100mm VESA hole pattern (n=4), M4, pitch =0.7 mm

## **Troubleshooting**

### **No power**

- Make sure A/C power cord is securely connected to the power adapter and the power supply is firmly connected to the Touch LED LCD Monitor.
- Plug another electrical device into the power outlet to verify that the outlet is supplying proper voltage.
- Make sure all signal cables are installed.

### **Power on but no screen image**

- Make sure the video cable supplied with the Touch LED LCD Monitor is tightly secured to the video output port on back of the computer. If not, tightly secure it.
- Adjust brightness.

### **Wrong or abnormal colors**

- If any colors (red, green, blue) are missing, check the video cable to make sure it is securely connected. Loose or broken pins in the cable connector could cause an improper connection.
- Connect the Touch LED LCD Monitor to another computer.

## **Planar Support**

### **Cables and Accessories**

To find cables and accessories for your Planar monitor, touch screen or other Planar products visit our online store at [www.PlanarOnline.com](http://www.PlanarOnline.com).

### **Technical Support**

Visit Planar at <http://www.planar.com/support> for operations manuals, touchscreen drivers, warranty information and access to Planar's Technical Library for online trouble shooting. To speak with Planar Customer Support please have your model and serial number available and dial:

### **Planar Support**

Tel: 1-866-PLANAR1 (866-752-6271) or +1 503-748-5799 outside the US.

Hours: 24 hours a day, 7 days a week.

Toll or long distance charges may apply.

## **Planar Systems, Inc.**

Customer Service

24x7 Online Technical Support: <http://www.planar.com/support>

1195 NE Compton Drive

Hillsboro, OR 97006

Tel: 1-866-PLANAR1(866-752-6271), or +1 503-748-5799 outside the United States,

Hours: 24 hours a day, 7 days a week

© 04/2020 Planar Systems, Inc.

Planar is a registered trademark of Planar Systems, Inc. Other brands and names are the property of their respective owners. Technical information in this document is subject to change without notice.



90101-23991

020-1193-00J