

2

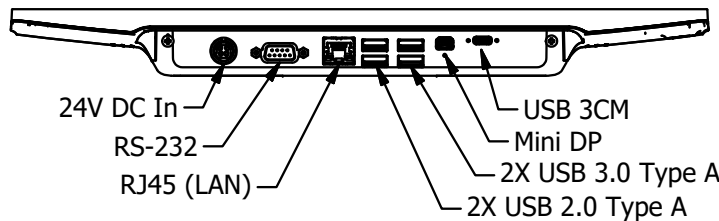

1

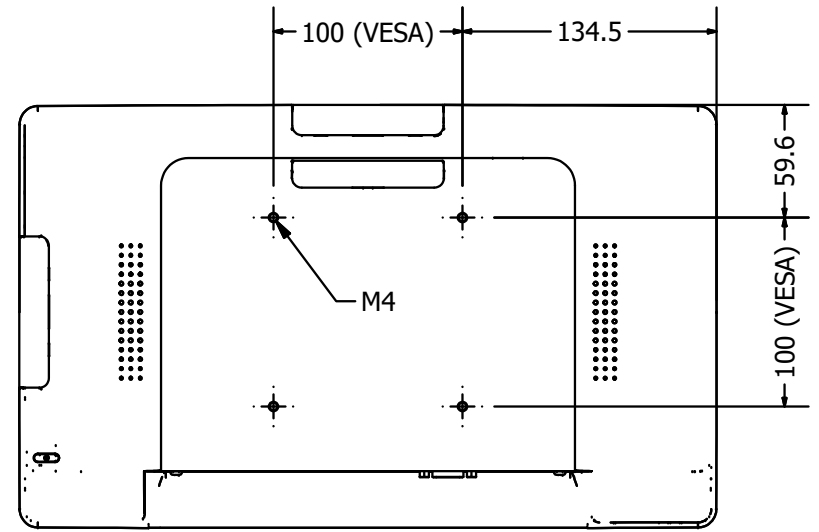
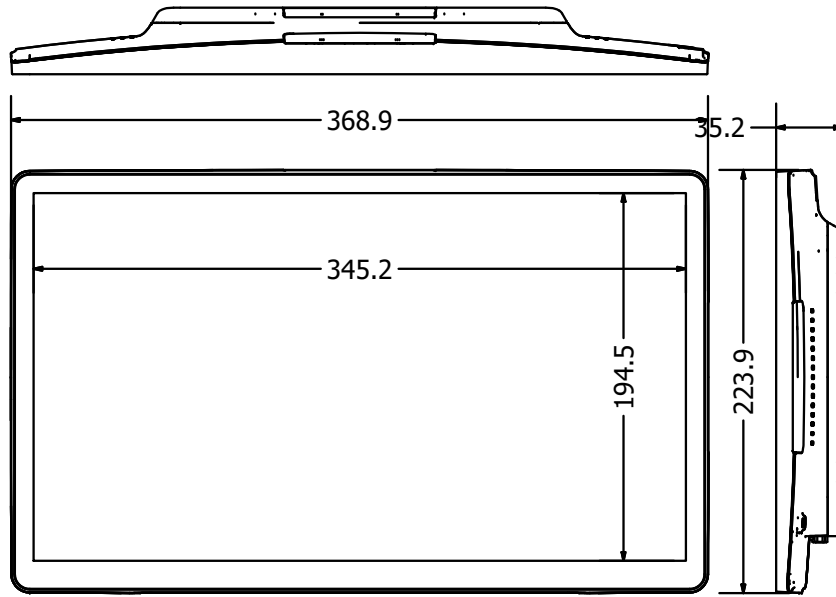

B

B

A

A

REV	DATE	DESCRIPTION	BY

THIS DRAWING AND OR TECHNICAL INFORMATION IS THE SOLE PROPERTY OF TES AMERICA, LLC. AND IS FURNISHED FOR AUTHORIZED USE ONLY AND ON THE UNDERSTANDING AND CONDITION THAT IT IS CONFIDENTIAL. NEITHER THIS DOCUMENT NOR THE INFORMATION DISCLOSED HEREIN SHALL BE DISCLOSED TO OTHERS, COPIED, REPRODUCED OR OTHERWISE TRANSFERRED TO OTHER DOCUMENTS, OR USED FOR MANUFACTURING OR ANY OTHER PURPOSE EXCEPT AS AUTHORIZED BY TES AMERICA, LLC.

**TOLERANCING**  
UNLESS OTHERWISE SPECIFIED  
ALL DIMS ARE mm  
.X ± 0.20 RADIUS ± 0.15  
.XX ± 0.10 ANGLES ± 0.5°  
DO NOT SCALE DRAWING

**MicroTouch** HOLLAND, MI 49423 - USA

IC-156P-AW4 (IEC-15B4)

DR: MPB	CK:	Material:	SCALE: NTS
DATE: 9/30/2021			SHEET: 1 OF 2
DWG. No. IC-156P-AW4			VER. 01

THIRD ANGLE VIEW

2



1

2



1

B

B

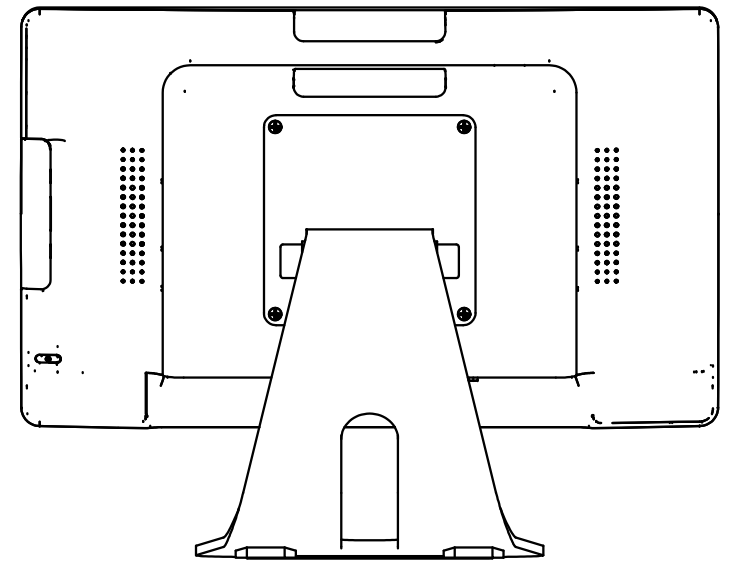
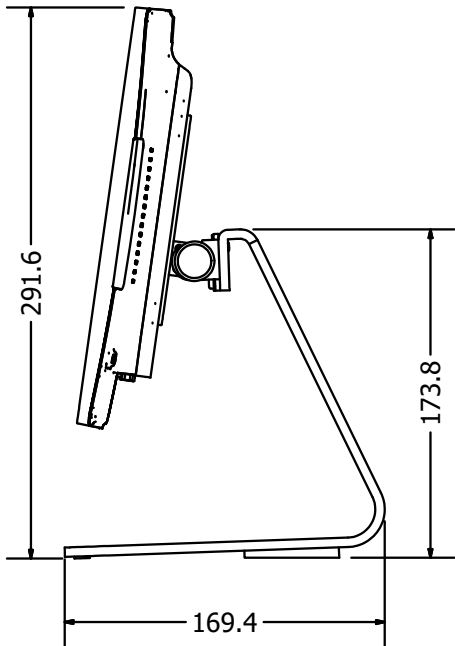
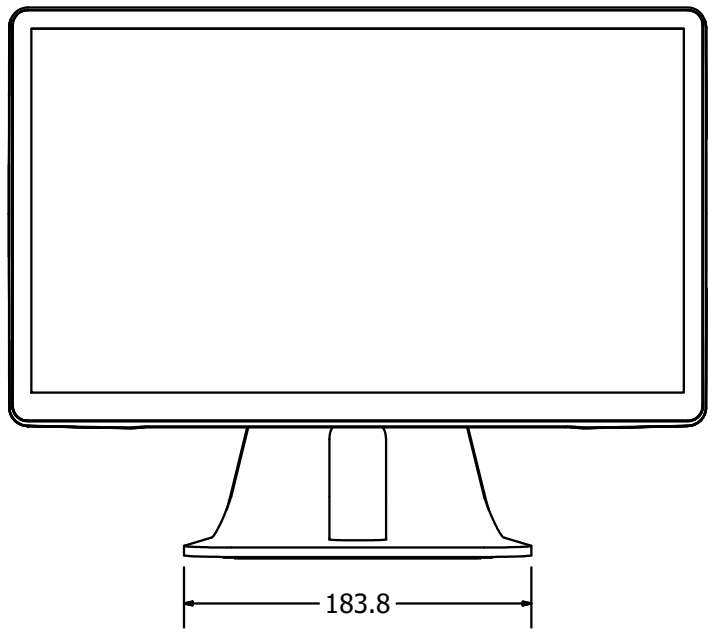

A

A

REV	DATE	DESCRIPTION	BY

THIS DRAWING AND OR TECHNICAL INFORMATION IS THE SOLE PROPERTY OF TES AMERICA, LLC. AND IS FURNISHED FOR AUTHORIZED USE ONLY AND ON THE UNDERSTANDING AND CONDITION THAT IT IS CONFIDENTIAL. NEITHER THIS DOCUMENT NOR THE INFORMATION DISCLOSED HEREIN SHALL BE DISCLOSED TO OTHERS, COPIED, REPRODUCED OR OTHERWISE TRANSFERRED TO OTHER DOCUMENTS, OR USED FOR MANUFACTURING OR ANY OTHER PURPOSE EXCEPT AS AUTHORIZED BY TES AMERICA, LLC.

**TOLERANCING**  
UNLESS OTHERWISE SPECIFIED  
ALL DIMS ARE mm  
.X ± 0.20 RADIUS ± 0.15  
.XX ± 0.10 ANGLES ± 0.5°  
DO NOT SCALE DRAWING

**MicroTouch** HOLLAND, MI 49423 - USA

IC-156P-AW4 (IEC-15B4)

DR: MPB	CK:	Material:	SCALE: NTS
DATE: 9/30/2021			SHEET: 2 OF 2
DWG. No. IC-156P-AW4			VER. 01

THIRD ANGLE VIEW

2



1