

SyncMaster 400MX-3, 460MX-3, 400FP-3, 460FP-3

LCD Display

User Manuals

The color and the appearance may differ depending on the product, and the specifications are subject to change without prior notice to improve the performance.



Safety Instructions

Notational



Note

These safety instructions must be followed to ensure your safety and prevent property damage.

Make sure to read the instructions carefully and use the product in the correct manner.

Warning / Caution



Failure to follow directions noted by this symbol could result in bodily harm or damage to the equipment.

Note



Prohibited



Important to read and understand at all times



Do not disassemble



Disconnect the plug from the outlet



Do not touch



Ground to prevent an electric shock

An administration fee may be charged if either

- (a) an engineer is called out at your request and there is no defect in the product (i.e. where you have failed to read this user manual).
- (b) you bring the unit to a repair centre and there is no defect in the product (i.e. where you have failed to read this user manual).

The amount of such administration charge will be advised to you before any work or home visit is carried out.

Power



When not used for extended period of time, set your computer to DPM.

If using a screen saver, set it to active screen mode.

The images here are for reference only, and are not applicable in all cases (or countries).

Shortcut to Anti-Afterimage Instructions



 Do not use a damaged power cord or plug or a damaged or loose power outlet.

- Otherwise, this may result in electric shock or fire.
-

Safety Instructions



▶ Do not touch the power plug with wet hands when removing or plugging the plug into the outlet.

- Otherwise, this may result in electric shock.



▶ Make sure to connect the power cord to a grounded power outlet.

- Otherwise, it may result in electric shock or personal injury.

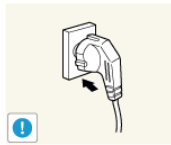

▶ Ensure that the power plug is plugged into the power outlet firmly and correctly.

- Otherwise, this may result in fire.

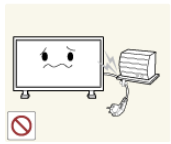

▶ Do not forcefully bend or pull the power plug and do not place any heavy material on it.

- Otherwise, this may result in fire.

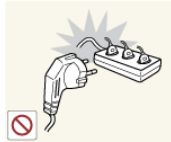

▶ Do not connect multiple appliances to the same power outlet.

- Otherwise, this may cause fire due to overheating.

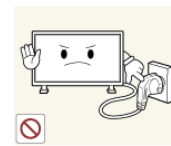

▶ Do not disconnect the power cord while using the product.

- Otherwise, this may result in damage to the product due to electric shock.

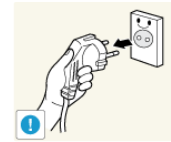

▶ To disconnect the apparatus from the mains, the plug must be pulled out from the mains socket, therefore the mains plug shall be readily operable.

- Otherwise, this may cause electric shock or fire.



▶ Use only the power cord provided by our company. Do not use the provided power cord of another product.

- Otherwise, this may result in fire or electric shock.

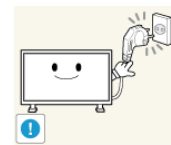

▶ Connect the power plug to a wall outlet that can be easily reached.

- When a problem occurs with the product, you must unplug the power plug to cut the power off completely. You cannot cut the power off completely using only the power button on the product.

Installation



Be sure to contact an authorized Service Center when installing your monitor in a location with heavy dust, high or low temperatures, high humidity, and exposed to chemical substances and where it operates for 24 hours such as at airports, train stations etc.

Failure to do so may cause serious damage to your monitor.

Safety Instructions



- ▶ Ensure that at least two persons lift and move the product.
- Otherwise, it may be dropped and cause personal injury, and/or damage the product.

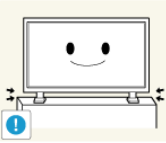

- ▶ When installing the product in a cabinet or rack, make sure that the front end of the bottom of the product does not project out.

- Otherwise, it may fall or cause personal injury.

- Use a cabinet or rack of a size appropriate to the product.



- ▶ DO NOT PLACE CANDLES, MOSQUITO REPELLANT, CIGARETTES AND ANY HEATING APPLIANCES NEAR THE PRODUCT.

- Otherwise, this may result in fire.

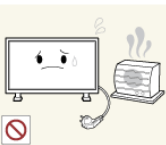

- ▶ Keep heating appliances as far away from the power cord or the product as possible.

- Otherwise, this may result in electric shock or fire.



- ▶ Do not install it in a badly ventilated location such as a bookcase or closet.

- Otherwise, this may result in fire due to an increase in the internal temperature.



- ▶ When putting the product down, make sure to put it down softly.

- Otherwise, this may result in damage to the screen display.

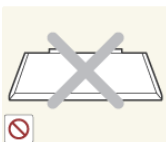

- ▶ Do not place the front of the product on the floor.

- Otherwise, this may result in damage to the screen display.

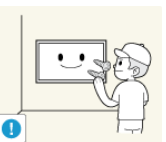

- ▶ Ensure that an authorized installation company installs the wall mount.

- Otherwise, it may fall and cause personal injury.

- Make sure to install the specified wall mount.

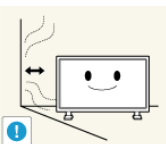

- ▶ Install your product in a well ventilated location. Ensure that there is a clearance of more than 4 inches (10 cm) from the wall.

- Otherwise, it may result in fire due to an increase in the internal temperature.



- ▶ Bend the outdoor antenna cable downwards at the location where it goes in so that rainwater does not flow in.

- If rainwater enters the product, it may result in electric shock or fire.



- ▶ Install the antenna far away from any high voltage cables.

- If the antenna touches or falls onto a high voltage cable, it may result in electric shock or fire.
-



- ▶ Ensure that the packaging vinyl is kept away from children.
- Otherwise, it may result in serious harm (suffocation) if children play with it.



- ▶ If the height of your monitor is adjustable, do not place any object or part of your body on the stand when lowering it.
- This may cause damage to the product or the person carrying it.

Clean



When cleaning the monitor case or the surface of the TFT-LCD screen, wipe with a slightly moistened, soft cloth.



- ▶ Do not spray cleaner directly onto the surface of the product.
- Otherwise, this may result in the discoloration and distortion of the structure and the screen surface may peel off.



- ▶ When cleaning the power plug pins or dusting the power outlet, clean it with a dry cloth.
- Otherwise, it may result in fire.

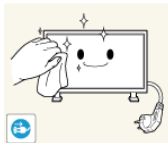

- ▶ When cleaning the product, make sure to disconnect the power cord.
- Otherwise, it may result in electric shock or fire.



- ▶ When cleaning the product, disconnect the power cord and clean it with a soft, dry cloth.
- (Do not use chemicals such as wax, benzene, alcohol, thinner, mosquito repellent, lubricant, or cleaner.) These may change the appearance of the product surface and peel off the indication labels on the product.

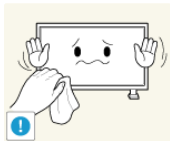

- ▶ Since the product housing is easily scratched, make sure to use the specified cloth only.



- ▶ When cleaning the product, do not spray water directly onto the main body of the product.
 - Ensure that water does not enter the product and that it is not wet.
 - Otherwise, this may result in electric shock, fire or a malfunction.
-

Others

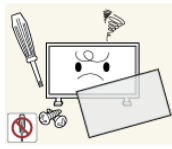

▶ The product is a high voltage product. Do not disassemble, repair or modify the product yourself.

- Otherwise, this may result in electric shock or fire. If the product needs to be repaired, contact a Service Center.



▶ If there is a strange smell or a strange sound or smoke is coming from the product, disconnect the power plug immediately and contact a Service Center.

- Otherwise, this may result in electric shock or fire.

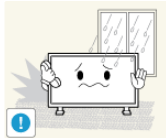

▶ Do not place this product in a location exposed to moisture, dust, smoke, water, or in a car.

- Otherwise, this may result in electric shock or fire.



▶ When you drop the product or the case is broken, turn the power off and disconnect the power cord. Contact a Service Center.

- Otherwise, this may result in electric shock or fire.

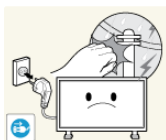

▶ If thunder or lightning is occurring, do not touch the power cord or antenna cable.

- Otherwise, this may result in electric shock or fire.



▶ Do not try to move the monitor by pulling only the wire or the signal cable.

- Otherwise, it may fall and result in electric shock, damage to the product or fire due to damage to the cable.

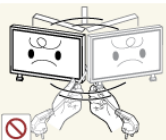

▶ Do not lift or move the product back and forwards or right and left while only holding the power cord or signal cables.

- Otherwise, it may fall and result in electric shock, damage to the product or fire due to damage to the cable.



▶ Make sure that the ventilating opening is not blocked by a table or curtain.

- Otherwise, it may result in fire due to an increase in the internal temperature.



▶ Do not place any containers containing water, vases, flowerpots, medicines as well as any metal on the product.

- If water or a foreign material enters the product, disconnect the power cord and contact a Service Center.

- This may result in a product malfunction, electric shock, or fire.

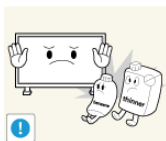

▶ Do not use or keep combustible spray or flammable material near the product.

- Otherwise, this may result in an explosion or fire.

Safety Instructions

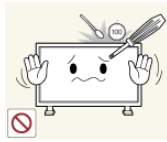

▶ Do not insert any metal, such as chopsticks, coins, pins and steel, or flammable objects, such as matches or paper, inside the product (through the ventilating openings, input and output terminals, etc).

- If water or foreign material enters the product, disconnect the power cord and contact a Service Center.
- Otherwise, this may result in electric shock or fire.

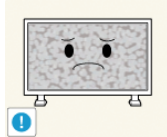

▶ When using a fixed screen for a long time, an afterimage or stain may occur.

- If you are not using your product for a long period of time, put it into sleep mode or use a moving screen saver.

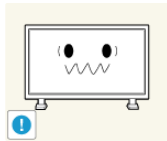

▶ Set a resolution and frequency appropriate to the product.

- Otherwise, your eyesight may be damaged.



▶ When using headphones or earphones, do not turn the volume too high.

- Having the sound too loud may damage your hearing.

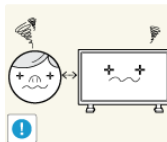

▶ To avoid eyestrain, do not sit too close to the product.

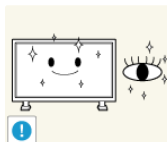

▶ Take a rest for at least five (5) minutes after using the monitor for one (1) hour.

This reduces eye fatigue.



▶ Do not install it in an unstable location such as an unstable rack or uneven surface or a location exposed to vibrations.

- Otherwise, it may fall and cause personal injury and/or damage the product.
- If you use the product in a location exposed to vibrations, it may damage the product and result in fire.



▶ When moving the product, turn the power off and disconnect the power plug, antenna cable, and all the cables connected to the product.

- Otherwise, it may result in electric shock or fire.



▶ Ensure that children do not hang onto the product or climb up onto the product.

- The product may fall and cause personal injury or death.

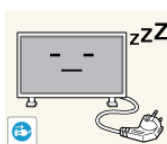

▶ If you do not use the product for a long period of time, disconnect the power cord from the power outlet.

- Otherwise, this may result in overheating or fire due to dust, and may result in fire due to electric shock or leakage.

Safety Instructions



▶ Do not place any heavy items or toys or confectionery, such as cookies etc. that may attract the attention of children and to the product.

- Your children may hang onto the product causing it to fall and this may result in personal injury or death.



▶ Be careful that children do not place the battery in their mouths when removed from the remote control. Place the battery in a location that children or infants cannot reach.

- If children have had the battery in their mouths, consult your doctor immediately.

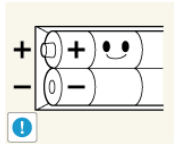

▶ When replacing the battery, insert it with the right polarity (+, -).

- Otherwise, the battery may become damaged or it may cause fire, personal injury or damage due to leakage of the internal liquid.

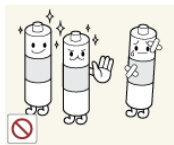

▶ Use only the specified standardized batteries, and do not use a new battery and a used battery at the same time.

- Otherwise, the batteries may be damaged or cause fire, personal injury or damage due to a leakage of the internal liquid.

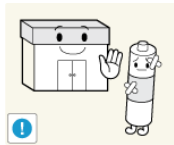

▶ The batteries (and rechargeable batteries) are not ordinary refuse and must be returned for recycling purposes. The customer is responsible for returning the used or rechargeable batteries for recycling.

- The customer can return used or rechargeable batteries to a nearby public recycling center or to a store selling the same type of the battery or rechargeable battery.

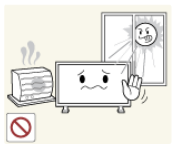

▶ Do not place the product in a location exposed to direct sunlight or near any heat such as a fire or heater.

- This may reduce the lifetime of the product, and may result in fire.

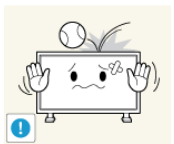

▶ Do not drop any objects onto the product or cause any impact to the product.

- Otherwise, this may result in electric shock or fire.



▶ Do not use a humidifier near the product.

- Otherwise, this may result in electric shock or fire.

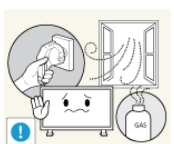

▶ When there is a gas leak, do not touch the product or the power plug; ventilate immediately.

- If a spark occurs, it may cause an explosion or fire.



▶ If the product has been turned on for a long time, the display panel becomes hot. Do not touch it.

Safety Instructions



- ▶ Keep the small accessories in a location out of the reach of children.



- ▶ Be careful when adjusting the angle of the product or the height of the stand.

- This may result in personal injury as your hand or fingers may become caught.
- Also, if you tilt the product too far, it may fall and cause personal injury.

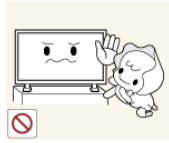

- ▶ Do not install the product in a location low enough for children to reach.

- Otherwise, it may fall and result in personal injury.
- Since the front part of the product is heavy, install the product on a level and stable surface.



- ▶ Do not put any heavy objects on the product.

- This may result in personal injury and/or damage to the product.
-

Introduction

Package Contents

Checking the Contents of the Package

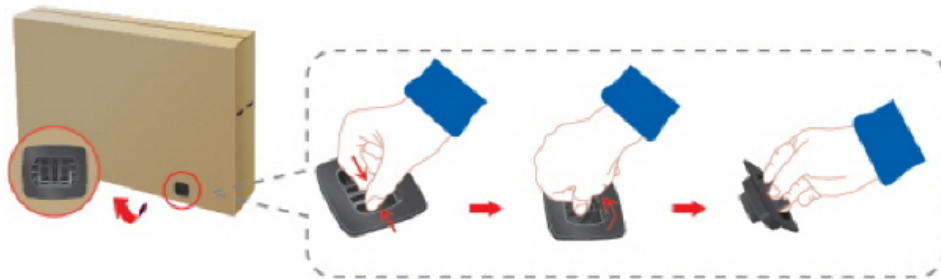

Remove the lock from the package box, as shown in the figure above.



Lift up the package box by holding the grooves on both sides of the package box.

Check the contents of the package.

Remove the Styrofoam and vinyl cover.

Note

- After unpacking the package, make sure to check the contents of the package.
- Store the packaging box in case you need to move the Product later.
- If any items are missing, contact your dealer.
- Contact a local dealer to purchase optional items.

Unpacking

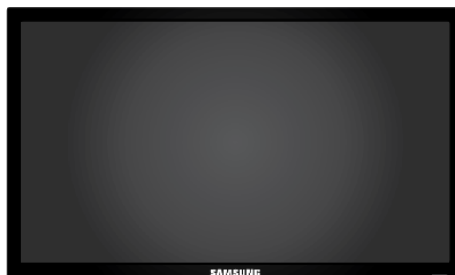

LCD Display

Manuals



Quick Setup Guide



Warranty Card



User Manual

(Not available in all locations)

Cables



Power Cord



D-Sub Cable

Others



Remote Control

(BP59-00138B)



Batteries (AAA X 2)

(Not available in all locations)

Sold separately



Semi Stand KIT



LAN Cable



USB Cable



RGB to BNC Cable



RGB to COMPONENT Cable

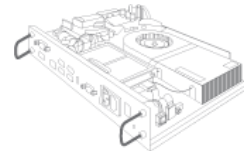

Network Box

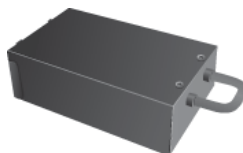
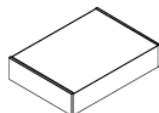

Sold separately

Wall Mount KIT

TV Tuner box

RS232C Cable

(US Only)

Your LCD Display

The color and the appearance may differ depending on the product, and the specifications are subject to change without prior notice to improve the performance.

Front



1 MENU button [MENU]

Opens the on-screen menu and exits from the menu. Also use to exit the OSD menu or return to the previous menu.

2 Navigate buttons (Up-Down buttons)

Moves from one menu item to another vertically or adjusts selected menu values.

3 Adjust buttons (Left-Right buttons) / Volume buttons

Moves from one menu item to another horizontally or adjusts selected menu values. When OSD is not on the screen, press the button to adjust volume.

4 ENTER button [ENTER]

Activates a highlighted menu item.

5 SOURCE button [SOURCE]

Switches from PC mode to Video mode. Selects the input source that an external device is connected to.

[PC] → [DVI] → [AV] → [Component] → [HDMI1] → [HDMI2] → [DisplayPort] → [MagicInfo] → [TV]



Note

- The [RGB/COMPONENT IN] port is compatible with RGB (PC) and Component signals.

However, the picture may display abnormally if the connected external input signal is different from the selected video signal.

- **MagicInfo** can only be enabled when a network box is connected.
- A TV tuner box (sold separately) must be connected to use the TV. (US Only)

6 *D.MENU button*

Opens the on-screen D.MENU.

 **Note**

The D.MENU button is activated when a TV tuner is connected and otherwise, the PIP button is enabled.

PIP button

Push the PIP button to turn the PIP screen On / Off.

7 *Power button [⏻]*

Use this button for turning the LCD Display on and off.

8 *Power indicator*

Shows PowerSaver mode by blinking green

 **Note**

See PowerSaver described in the manual for further information regarding power saving functions. For energy conservation, turn your LCD Display OFF when it is not needed or when leaving it unattended for long periods.

9 *Remote Control Sensor*

Aim the remote control towards this spot on the LCD Display.

Rear

 **Note**

See the "Connections" section for details about cable connections. The LCD Display's configuration at the back may vary slightly depending on the model.



A



1 POWER SW ON [|] / OFF

Switches the LCD Display On/Off.

2 POWER

The power cord plugs into the LCD Display and the wall outlet.

B

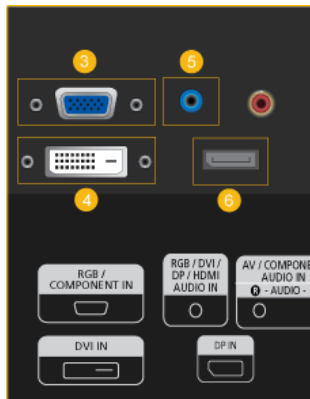

3 RGB/COMPONENT IN (PC/COMPONENT Connection Terminal (Input))

- Connect the [RGB/COMPONENT IN] port on the monitor to the RGB port on the PC using the D-SUB cable.
- Connect the [RGB/COMPONENT IN] port on the monitor to the COMPONENT port on the external device using the RGB to COMPONENT cable.
- Connect the [RGB/COMPONENT IN] port on the monitor to the BNC port on the PC using the RGB to BNC cable.

4 DVI IN (PC Video Connection Terminal)

Connect the [DVI IN] port on the monitor to the DVI port on the PC using the DVI cable.

5 RGB/DVI/DP/HDMI AUDIO IN (PC/DVI/DP/HDMI Audio Connection Terminal (Input))

Connect the [RGB/DVI/DP/HDMI AUDIO IN] terminal of the monitor and the speaker output terminal of your computer's sound card using a stereo cable (sold separately).

6 DP IN

Receives a signal from the Display port.

Connect a DP cable to [DP IN] on the product and DP IN on another display.

C

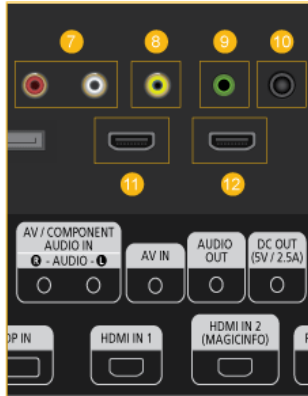

7 AV/COMPONENT AUDIO IN [R-AUDIO-L]

Connect the [AV/COMPONENT AUDIO IN [R-AUDIO-L]] port on the monitor to the audio output port on the PC or on the external device using an audio cable.

8 AV IN

Connect the [AV IN] terminal of your monitor to the video output terminal of the external device using a VIDEO cable.

9 AUDIO OUT

Connect a headphone or an External speaker.

10 DC OUT

Make sure to use connecting [DC OUT] terminal to the authorized TV-Tuner Box.(US Only)



Otherwise, this may result in damage to the product.

11 HDMI IN 1

- Connect the [HDMI IN 1] terminal at the back of your LCD Display to the HDMI terminal of your digital output device using a HDMI cable.
- Up to HDMI 1.3 can be supported.



Note

- A normal external device (DVD player or camcorder, etc.) or a TV tuner box can be connected to the [HDMI IN 1] terminal.
- To use a TV tuner box (US Only), make sure to connect it to the [HDMI IN 1] terminal.

12 HDMI IN 2 (MAGICINFO)

- Connect the [HDMI IN 2 (MAGICINFO)] terminal at the back of your LCD Display to the HDMI terminal of your digital output device using a HDMI cable.
- Up to HDMI 1.3 can be supported.

**Note**

To use **MagicInfo**, the network box specified separately by Samsung must be installed inside the product and the **MagicInfo** output of the network box must be connected to the *[HDMI IN 2 (MAGICINFO)]* terminal.

For more information on how to purchase and install a network box, contact Samsung Electronics.

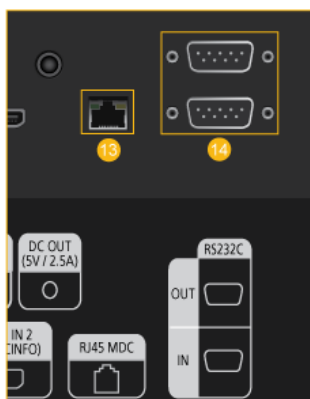
D**13** *RJ 45 MDC (MDC PORT)*

MDC(Multiple Display Control) Program Port

Connect the LAN cable to *[RJ45 MDC]* on the product and LAN on the PC. To use an MDC, the MDC Program must be installed on the PC.

**Note**

Go to **Multi Control** and select **RJ45 MDC** as the **MDC Connection**.

14 *RS232C OUT/IN (RS232C Serial PORT)*

MDC(Multiple Display Control) Program Port

Connect a serial cable (cross type) to *[RS232C]* on the product and RS232C on the PC. To use an MDC, the MDC Program must be installed on the PC.

**Note**

Go to **Multi Control** and select **RS232C MDC** as the **MDC Connection**.

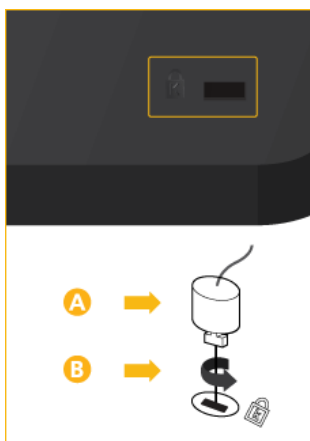
E*Kensington Lock slot*

A Kensington Lock is an anti-theft device that enables users to lock the product so that they can safely use it in public locations. Since the shape and usage of the locking device may differ depending on the model and the manufacturer, for more information, refer to the User Manual supplied with the locking device for more information.

**Note**

You must purchase the Kensington Lock separately.

To lock the product, follow these steps:

1. Wrap the Kensington lock cable around a large, stationary object such as a desk or chair.
2. Slide the end of the cable with the lock attached through the looped end of the Kensington lock cable.
3. Insert the Kensington Lock into the security slot (**B**) on the back of the display.
4. Lock the lock (**A**).



Note

- These are general instructions. For exact instructions, see the User Manual supplied with the locking device.
- You can purchase the locking device from an electronics store, an online shop, or our service Center.

F Connecting a Network Box (sold separately)

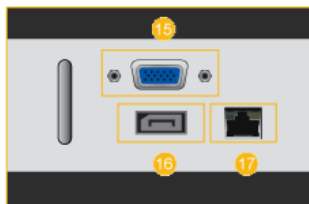

15 *RGB OUT*

MagicInfo video output port

16 *MAGICINFO OUT*

This is the output terminal for the video, audio, and control signals of **MagicInfo**.

It can be used by connecting it to the [HDMI IN 2 (MAGICINFO)] terminal using a **DP to HDMI** cable.

17 *LAN (LAN Connection Terminal)*

Connects to a LAN cable to allow Internet or network access in **MagicInfo** mode.

G Connecting a Network Box (sold separately)

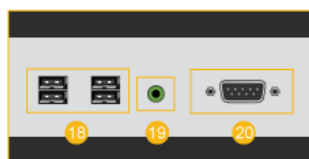

18 *USB (USB Connection Terminal)*

Keyboard / Mouse, Mass Storage Device Compatible.

19 *AUDIO OUT*

Connect a headphone or an External speaker.

20 RS232C (RS232C Serial PORT)

Serial port

H Connecting a Network Box (sold separately)



21 POWER

Connect the [POWER] terminal of the product and the [POWER] terminal of the monitor using a power extension cable.

22 POWER

Connects to a mains socket via the power cord.

23 POWER SW ON [I] / OFF

Turns the network box on or off.

 **Note**

- See the "Connections" section for details about cable connections.
- The power switches of both of the monitor and the network box must be turned on for the network box to operate normally.

Remote Control

 **Note**

The performance of the remote control may be affected by a TV or other electronic device operating near the LCD Display , causing a malfunction due to interference with the frequency.

A TV tuner box (sold separately) must be connected to use the TV. (US Only)

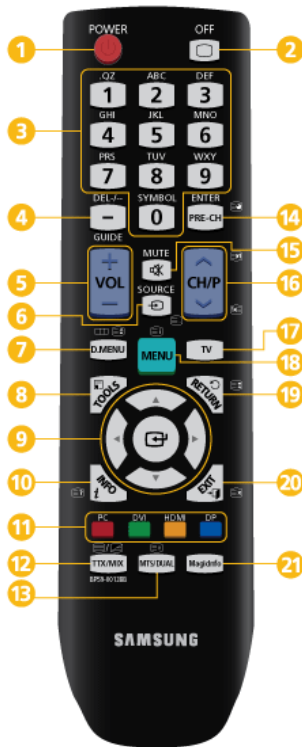

- 1 POWER
- 2 OFF
- 3 Number Buttons
- 4 /GUIDE button
- 5 + VOL -
- 6 SOURCE
- 7 D.MENU
- 8 TOOLS
- 9 Up-Down Left-Right buttons
- 10 INFO
- 11 The Color button and the PC/DVI/HDMI/DP selection button.
- 12 TTX/MIX
- 13 MTS/DUAL
- 14 ENTER/PRE-CH
- 15 MUTE
- 16 CH/P
- 17 TV
- 18 MENU
- 19 RETURN
- 20 EXIT
- 21 MagicInfo

1 POWER

Turns the product On.

2 OFF

Turns the product Off.

3 Number Buttons

Used to enter the password during the OSD adjustment or to use MagicInfo.

Press to change the channel.

4 /GUIDE button

The "-" button is used to select Digital channels.

Electronic Program Guide (EPG) display.

Note

This button can only be used in TV mode while a TV tuner box (sold separately) is connected.

5 + VOL -

Adjusts the audio volume.

6  SOURCE

Selects a connected external input source or **MagicInfo** mode.

Press the button to change the input signal SOURCE.

Changing the SOURCE is only allowed for external devices that are connected to the LCD Display at the time.

7  D.MENU

DTV menu display

 **Note**

This button can only be used in TV mode while a TV tuner box (sold separately) is connected.

8  TOOLS

Use to quickly select frequently used functions.

 **Note**

This function does not work for this LCD Display.

9 Up-Down Left-Right buttons

Moves from one menu item to another horizontally, vertically or adjusts selected menu values.

10  INFO

Current picture information is displayed on the upper left corner of the screen.

11 The Color button and the PC/DVI/HDMI/DP selection button.

In TV mode, these buttons can be used to configure a list of channels.

You can select the **PC**, **DVI**, **HDMI** or **DP(DisplayPort)** external input directly in a mode other than TV mode.

12  TTX/MIX

TV channels provide written information services via teletext.

- Teletext Buttons

6 , **7** , **10** , **12** , **13** , **14** , **16** , **18** , **19** , **20** 

 **Note**

This function does not work for this LCD Display.

13 MTS/DUAL

MTS-

You can select MTS (Multichannel Television Stereo) mode.

	Audio Type	MTS/S_Mode	Default
FM Stereo	Mono	Mono	Manual
	Stereo	Mono ↔ Stereo	Change
	SAP	Mono ↔ SAP	Mono

DUAL-

STEREO/MONO, DUAL I / DUAL II and MONO/NICAM MONO/NICAM STEREO can be operated depending on the

broadcasting type by using the DUAL button on the remote control while watching TV.

 **Note**

Enabled when a TV tuner box is connected.

14  ENTER/PRE-CH

This button is used to return to the immediately previous channel.

 **Note**

Enabled when a TV tuner box is connected.

15  MUTE

Pauses (mutes) the audio output temporarily. This is displayed on the lower left corner of the screen. The audio comes back on if MUTE or + VOL - is pressed in the Mute mode.

16  CH/P

In **TV** mode, selects TV channels.

 **Note**

Enabled when a TV tuner box is connected.

17  TV

Allows you to watch an analogue or digital TV.

 **Note**

Enabled when a TV tuner box is connected.

18  MENU

Opens the on-screen menu and exits from the menu or closes the adjustment menu.

19  RETURN

Returns to the previous menu.

20  EXIT

Exits from the menu screen.

21  MagicInfo

MagicInfo Quick Launch Button.

 **Note**

Enabled when a Network box is connected.

User Installation Guide

 **Note**

- Be sure to call an installation expert of Samsung Electronics to install the product.
- The warranty becomes invalid if the product is installed by someone other than a professional authorized by Samsung Electronics.
- A Samsung Electronics service center can provide details.

Tilt Angle and Rotation

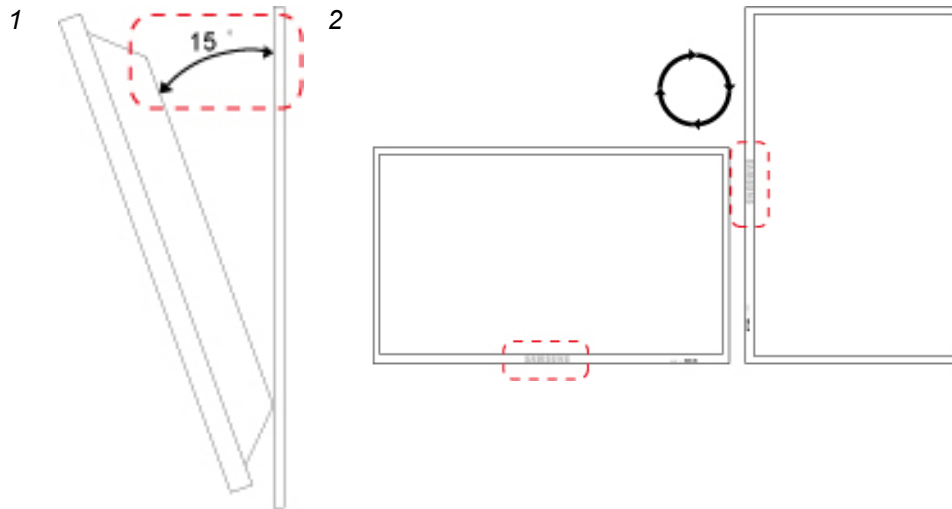

1. The product can be tilted up to 15 degrees from a vertical wall.
2. To use the product in portrait mode, rotate it clockwise so that the LED indicator is at the bottom.

Ventilation requirement

1. Vertical wall mount condition

<Side view>

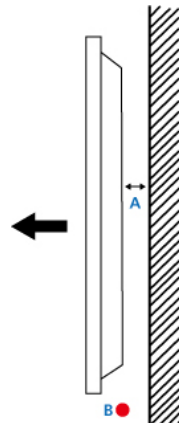

A : min. 40 mm

B: Ambient temperature Measuring point < 35°C

- When installing the product onto a vertical wall, be sure there is a 40 mm space or more behind the product for ventilation, as shown above, and maintain the ambient temperature at 35°C or lower.

Note

A Samsung Electronics service center can provide details.

2. Embedded Mount guide

<Side view>

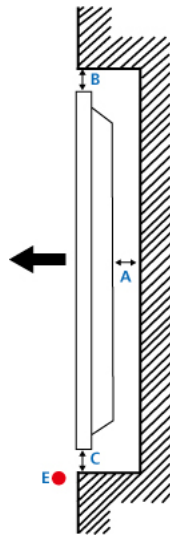

<Top view>

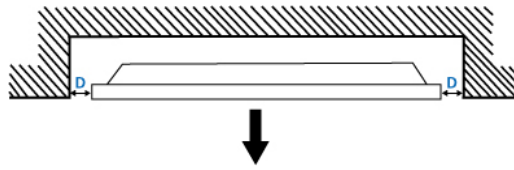

A : min. 40 mm

B : min. 70 mm

C : min. 50 mm

D : min. 50 mm

E : Ambient temperature Measuring point < 35°C

- When embedding the product in a wall, be sure there is some space behind the product for ventilation, as shown above, and maintain the ambient temperature at 35°C or lower.

Note

A Samsung Electronics service center can provide details.

3. Floor mount guide

<Side view>

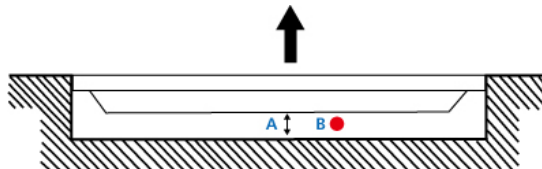

A : min. 50 mm

B: Ambient temperature Measuring point < 20°C

- When embedding the product in the floor, be sure there is a 50 mm space or more behind the product for ventilation, as shown above, and maintain the ambient temperature at 20°C or lower.

Note

A Samsung Electronics service center can provide details.

Mechanical Layout

(400MX-3, 400FP-3)

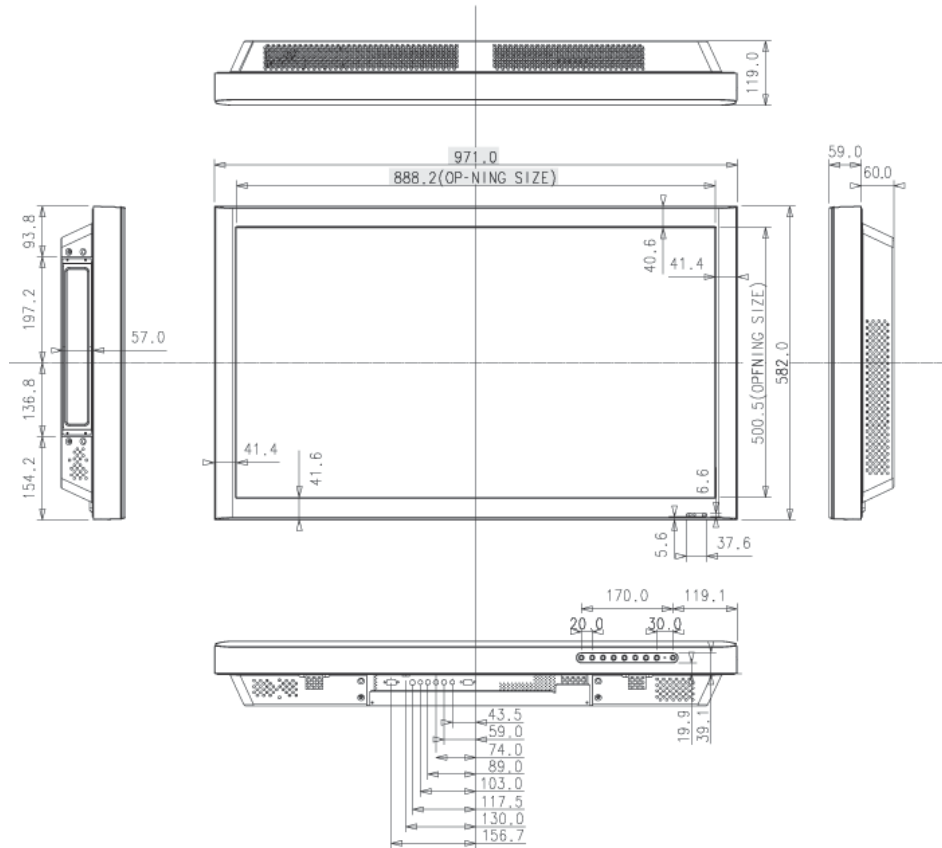

(460MX-3, 460FP-3)

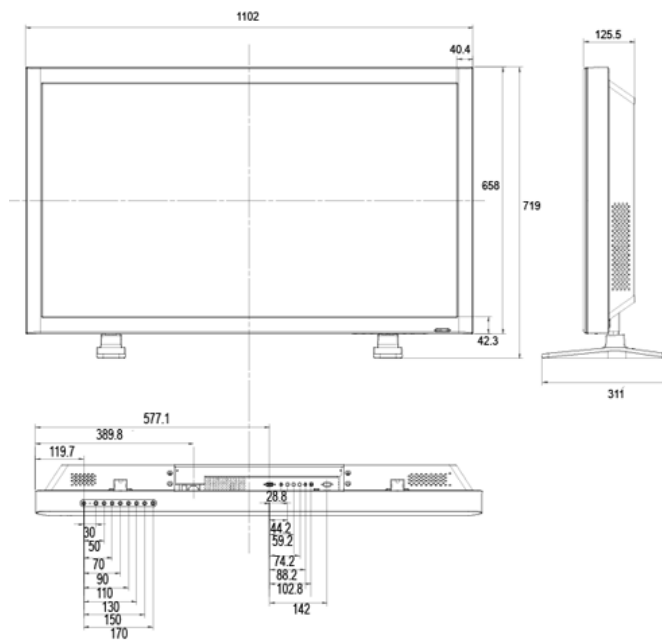

Installation VESA Bracket

- When installing VESA, make sure to comply with the international VESA standards.

- Purchasing VESA Bracket and Installation Information : Please contact your nearest SAMSUNG Distributor to place an order. After your order is placed, installation professionals will visit you and install the bracket.
- At least 2 persons are needed in order to move the LCD Display.
- SAMSUNG is not responsible for any product damage or any injury caused by installation at customer's discretion.

Dimensions

(400MX-3, 400FP-3)

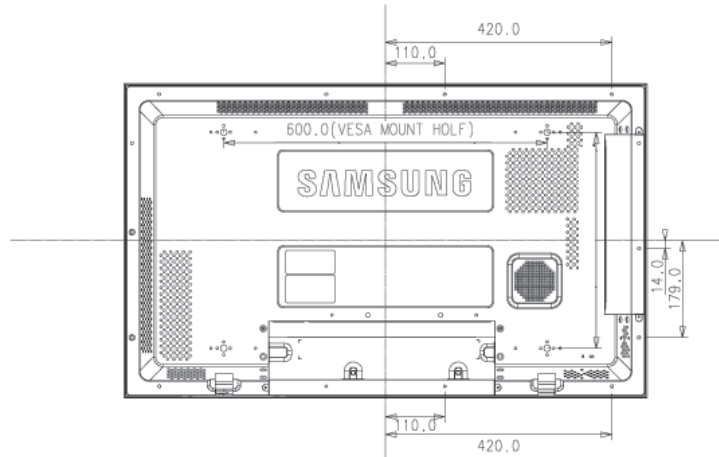

(460MX-3, 460FP-3)

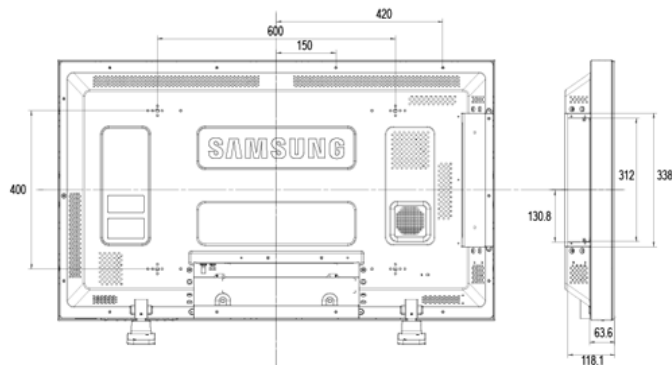

Notice

For securing the bracket on a wall, use only machine screws of 6 mm diameter and 8 to 12 mm length.

Accessories (sold separately)

- Dimension with welcome board

(400MX-3, 400FP-3)

Introduction

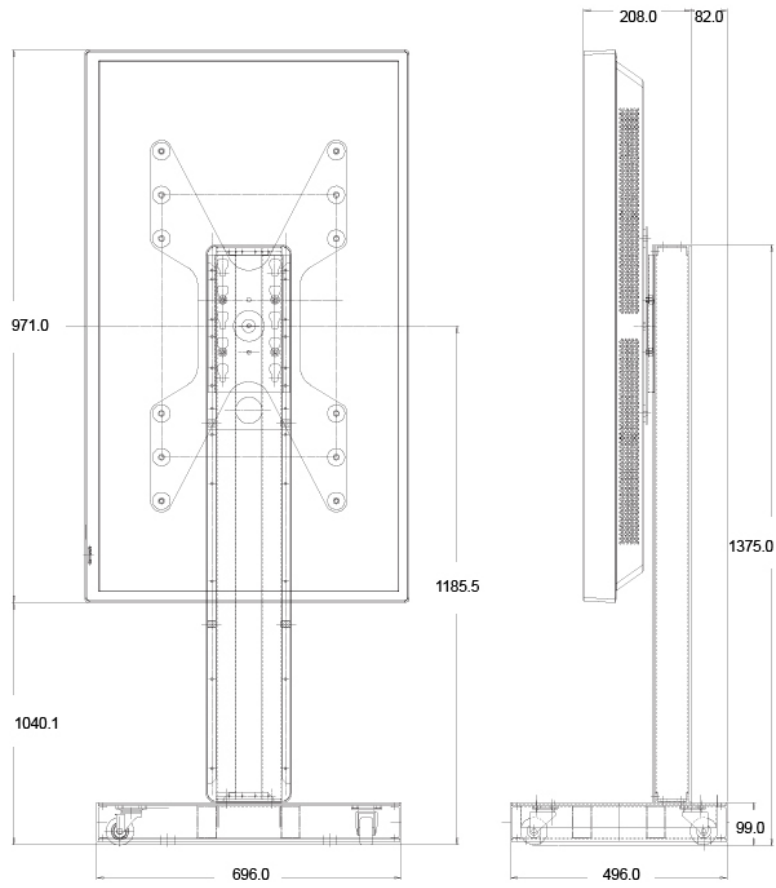

(460MX-3, 460FP-3)

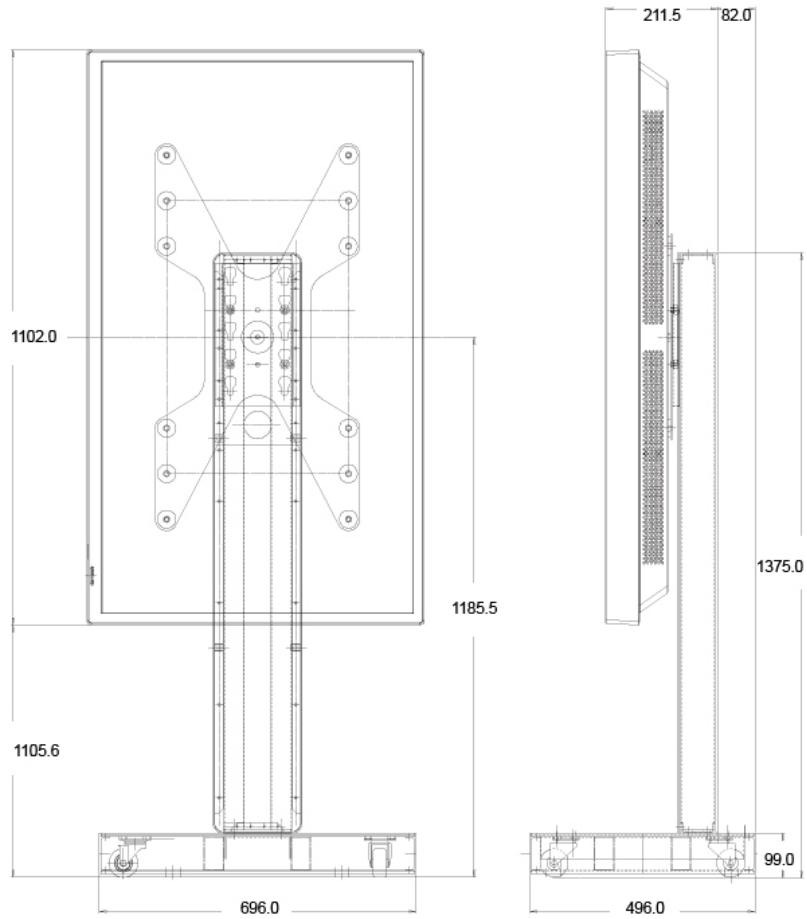

- Dimension with other accessories

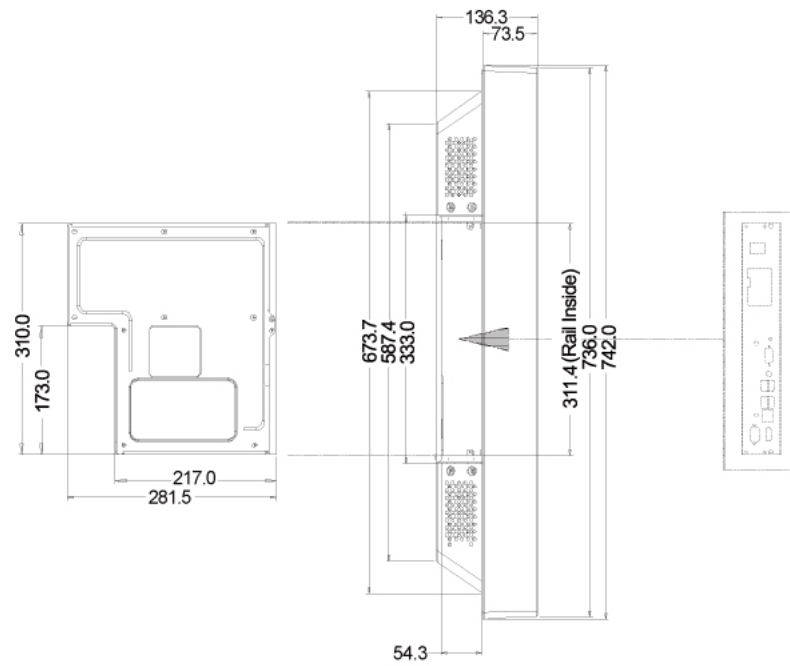

Wall Bracket Installation

- Contact a technician for installing the wall bracket.

- SAMSUNG Electronics is not responsible for any damages to the product or harm to customers when the installation is done by the customer.
- This product is for installing on cement walls. The product may not stay in place when installed on plaster or wood.

Components

Only use the components and accessories shipped with the product.

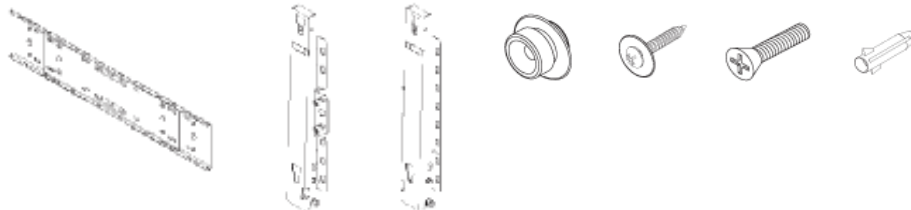

Wall Bracket(1) Hinge(Left 1, Right 1) Plastic Hanger (A)(11) Screw (B)(4) Anchor (11)

To mount the product on the wall bracket

The shape of the product may vary depending on the model. (The assemblies of the plastic hanger and the screw are the same)

1. Remove the 4 screws on the back of the product.

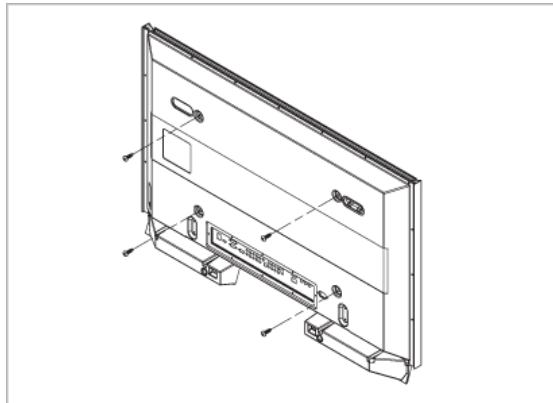

2. Insert the screw B into the plastic hanger.

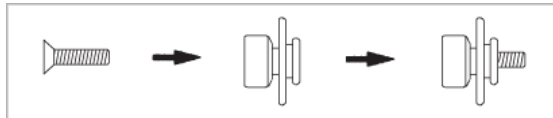

Notice

- Mount the product on the wall bracket and make sure it is properly fixed to the left and right plastic hangers.
 - Be careful when installing the product on the bracket as fingers can be caught in the holes.
 - Make sure the wall bracket is securely fixed to the wall, or the product may not stay in place after installation.
3. Tighten the 4 screws in step 2 (plastic hanger + screw B) to the rear holes of the product.

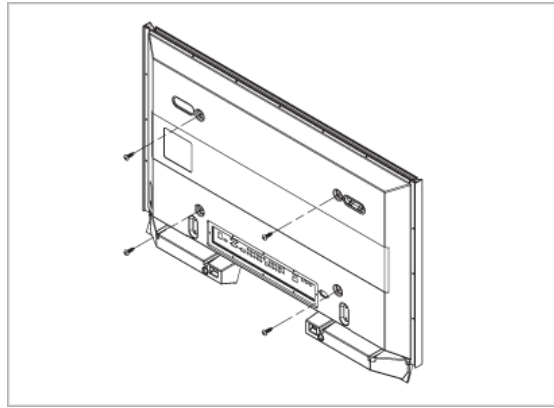

4. Remove safety pin (3) and insert the 4 product holders into the corresponding bracket holes (1). Then place the product(2) so that it is firmly fixed to the bracket. Make sure to re-insert and tighten the safety pin (3) to securely hold the product to the bracket.

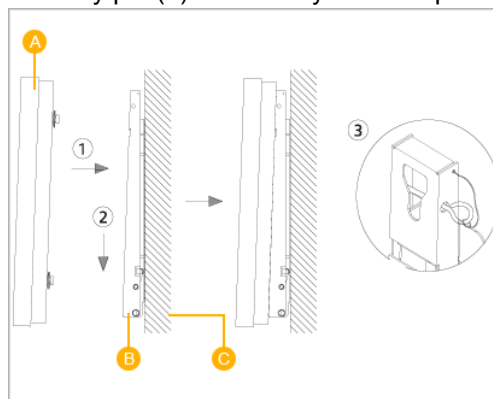

- A - LCD Display
- B - Wall Bracket
- C - Wall

Wall Bracket Angle Adjustment

Adjust the bracket angle to -2° before installing it on the wall.

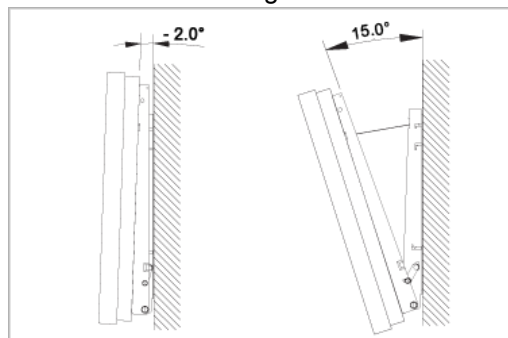

1. Fix the product to the wall bracket.
2. Hold the product at the top in the center and pull it forward (direction of the arrow) to adjust the angle.

Note

You can adjust the bracket angle between -2° and 15° .

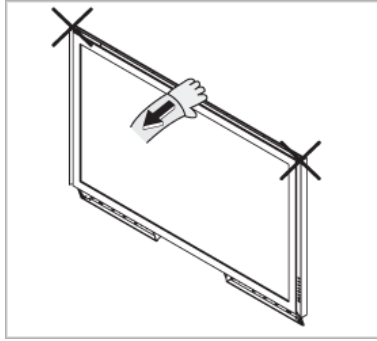

Make sure to use the top center, and not the left or the right side of the product to adjust the angle.

Remote Control (RS232C)

Cable connections

interface	RS232C(9 pin)
pin	TxD(No.2) RxD(No.3) GND(No.5)
Bits rate	9600 bps
Data Bits	8 bit
Parity	None
Stop Bits	1 bit
Flow control	None
Maximum length	15 m (only shielded type)

- Pin assignment

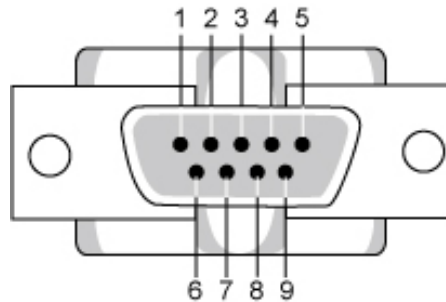

Pin	Signal
1	Data Carrier Detect
2	Received Data
3	Transmitted Data
4	Data Terminal Ready
5	Signal Ground
6	Data Set Ready
7	Request to Send
8	Clear to Send
9	Ring Indicator

- RS232C cable

Connector : 9-pin D-Sub

Cable : Cross (reversed) cable

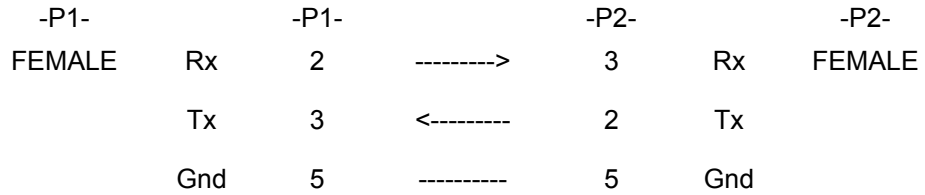
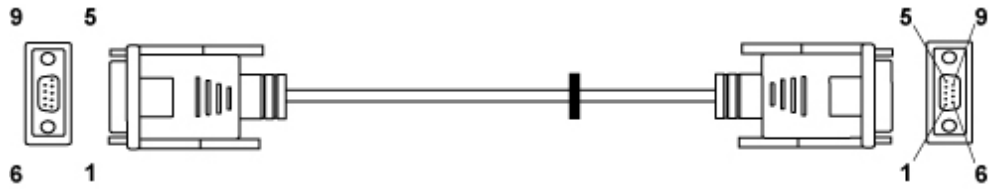

- Connecting method

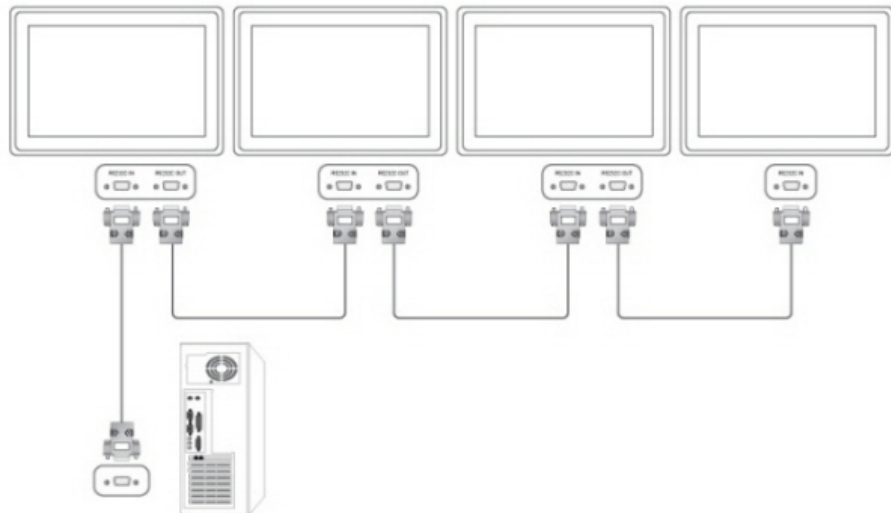

Control codes

- Get control

Header	command	ID	DATA Length	CheckSum
0xAA	command type		0	

- Set control

Header	command	ID	DATA Length	DATA	CheckSum
0xAA	command type		1	Value	

- commanding words

No.	command type	command	Value range
-----	--------------	---------	-------------

1	Power control	0x11	0~1
2	Volume control	0x12	0~100
3	Input source control	0x14	-
4	Screen Mode control	0x18	-
5	Screen Size control	0x19	0~255
6	PIP on/off control	0x3C	0~1
7	Auto adjustment control	0x3D	0
8	Video wall Mode control	0x5C	0~1
9	Safety Lock	0x5D	0~1

- ID should show hexadecimal value of assigned ID, but ID 0 should be 0xFF.

- Every communication will be made in hexadecimals and Checksum is the sum of all remainings. If it exceeds two digits, for example, it is $11+FF+01+01=112$, discard the number in the first digit like below.

example) PowerOn&ID=0

Header	command	ID	DATA Length	DATA 1	CheckSum
0xAA	0x11		1	Power	

Header	command	ID	DATA Length	DATA 1	12
0xAA	0x11		1	1	

If you want to control every mechanism connected with Serial Cable regardless of its ID, set ID part to "0xFE" and send commands. At the time, each product will follow commands but it will not respond with ACK.

- Power Control

- Function

Personal Computer turns TV / Monitor power ON/OFF.

- Get Power ON/OFF Status

Header	command	ID	DATA Length	CheckSum
0xAA	0x11		0	

- Set Power ON/OFF

Header	command	ID	DATA Length	DATA	CheckSum
0xAA	0x11		1	Power	

Power : Power code to be set on TV / Monitor

1 : Power ON

0 : Power OFF

- Ack

Header	com-mand	ID	DATA Length	Ack/Nak	r-CMD	Val1	Check Sum
0xAA	0xFF			3	'A'	0x11	

Power : Same as above

- Nak

Header	com-mand	ID	DATA Length	Ack/Nak	r-CMD	Val1	Check Sum
0xAA	0xFF			3	'N'	0x11	

ERR : Error code that shows what occurred error is

- Volume Control

- Function

Personal Computer changes volume of TV / Monitor.

- Get Volume Status

Header	command	ID	DATA Length	Checksum
0xAA	0x12			

- Set Volume

Header	command	ID	DATA Length	DATA	Checksum
0xAA	0x12			1	

Volume : Volume value code to be set on TV / Monitor (0 ~ 100)

- Ack

Header	com-mand	ID	DATA Length	Ack/Nak	r-CMD	Val1	Check Sum
0xAA	0xFF			3	'A'	0x12	

Volume : Same as above

- Nak

Header	com-mand	ID	DATA Length	Ack/Nak	r-CMD	Val1	Check Sum
0xAA	0xFF			3	'N'	0x12	

ERR : Error code that shows what occurred error is

- Input Source Control

- Function

Personal Computer changes input source of TV / Monitor.

- Get Input Source Status

Header	command	ID	DATA Length	CheckSum
0xAA	0x14		0	

- Set Input Source

Header	command	ID	DATA Length	DATA	CheckSum
0xAA	0x14		1	Input Source	

Input Source : Input Source code to be set on TV / Monitor

0x14	PC
0x1E	BNC
0x18	DVI
0x0C	AV
0x04	S-Video
0x08	Component
0x20	MagicInfo
0x1F	DVI_VIDEO
0x30	RF(TV)
0x40	DTV
0x21	HDMI1
0x22	HDMI1_PC
0x23	HDMI2
0x24	HDMI2_PC
0x25	DisplayPort

 **Caution**

DVI_VIDEO, HDMI1_PC, HDMI2_PC → Get Only

In the case of MagicInfo, only possible with models include MagicInfo

In the case of TV, only possible with models include TV.

- Ack

Header	com- mand	ID	DATA Length	Ack/Nak	r-CMD	Val1	Check Sum
--------	--------------	----	----------------	---------	-------	------	--------------

0xAA	0xFF		3	'A'	0x14	Input Source	
------	------	--	---	-----	------	--------------	--

Input Source : Same as above

- Nak

Header	com-mand	ID	DATA Length	Ack/Nak	r-CMD	Val1	Check Sum
0xAA	0xFF		3	'N'	0x14	ERR	

ERR : Error code that shows what occurred error is

- Screen Mode Control

- Function

Personal Computer changes "Screen Mode" of TV/Monitor.

Cannot be controlled when Video Wall is on.



Caution

Only works with models include TV.

- Get Screen Mode Status

Header	command	ID	DATA Length	Checksum
0xAA	0x18		0	

- Set Picture Size

Header	command	ID	DATA Length	DATA	Checksum
0xAA	0x18		1	Screen Mode	

Screen Mode : Screen Mode code to be set on TV / Monitor

0x01	16 : 9
0x04	Zoom
0x31	Wide Zoom
0x0B	4 : 3

- Ack

Header	com-mand	ID	DATA Length	Ack/Nak	r-CMD	Val1	Check Sum
0xAA	0xFF		3	'A'	0x18	Screen Mode	

Screen Mode : Same as above

- Nak

Header	com- mand	ID	DATA Length	Ack/Nak	r-CMD	Val1	Check Sum
0xAA	0xFF		3	'N'	0x18	ERR	

ERR : Error code that shows what occurred error is

- Screen Size Control

- Function

Personal Computer recognizes the screen size of TV / Monitor.

- Get Screen Size Status

Header	command	ID	DATA Length	Checksum
0xAA	0x19		0	

- Ack

Header	com- mand	ID	DATA Length	Ack/Nak	r-CMD	Val1	Check Sum
0xAA	0xFF		3	'A'	0x19	Screen Size	

Screen Size : Screen Size of TV / Monitor (Range : 0 ~ 255, Unit : Inch)

- Nak

Header	com- mand	ID	DATA Length	Ack/Nak	r-CMD	Val1	Check Sum
0xAA	0xFF		3	'N'	0x19	ERR	

ERR : Error code that shows what occurred error is

- PIP ON / OFF Control

- Function

The PC turns the PIP function of a TV or Monitor ON / OFF.

This does not operate in MagicInfo mode.

- Get the PIP ON / OFF Status

Header	command	ID	DATA Length	Checksum
0xAA	0x3C		0	

- Set the PIP ON / OFF

Header	command	ID	DATA Length	DATA	CheckSum
0xAA	0x3C		1	PIP	

PIP : The PIP ON / OFF code to set for the TV or Monitor

1 : PIP ON

0 : PIP OFF

- Ack

Header	com-mand	ID	DATA Length	Ack/Nak	r-CMD	Val1	Check Sum
0xAA	0xFF		3	'A'	0x3C	PIP	

PIP : Same as above

- Nak

Header	com-mand	ID	DATA Length	Ack/Nak	r-CMD	Val1	Check Sum
0xAA	0xFF		3	'N'	0x3C	ERR	

ERR : Error code that shows what occurred error is

- Auto Adjustment Control (PC, BNC Only)

- Function

Personal Computer controls PC system screen automatically.

- Get Auto Adjustment Status

None

- Set Auto Adjustment

Header	command	ID	DATA Length	DATA	CheckSum
0xAA	0x3D		1	Auto Adjust-ment	

Auto Adjustment : 0x00 (Always)

- Ack

Header	com-mand	ID	DATA Length	Ack/Nak	r-CMD	Val1	Check Sum
--------	----------	----	-------------	---------	-------	------	-----------

0xAA	0xFF		3	'A'	0x3D	Auto Ad-justment	
------	------	--	---	-----	------	------------------	--

- Nak

Header	com-mand	ID	DATA Length	Ack/Nak	r-CMD	Val1	Check Sum
0xAA	0xFF		3	'N'	0x3D	ERR	

ERR : Error code that shows what occurred error is

- Video Wall Mode Control

- Function

Personal Computer converts Video Wall Mode of TV / Monitor when Video Wall is ON.

Only works with TV / Monitor where Video Wall is on.

Does not operate in MagicInfo

- Get Video Wall Mode

Header	command	ID	DATA Length	Checksum
0xAA	0x5C		0	

- Set Video Wall Mode

Header	command	ID	DATA Length	DATA	Checksum
0xAA	0x5C		1	Video Wall Mode	

Video Wall Mode : Video Wall Mode code to be set on TV / Monitor

1 : **Full**

0 : **Natural**

- Ack

Header	com-mand	ID	DATA Length	Ack/Nak	r-CMD	Val1	Check Sum
0xAA	0xFF		3	'A'	0x5C	Video Wall Mode	

Video Wall Mode : same as above

- Nak

Header	com-mand	ID	DATA Length	Ack/Nak	r-CMD	Val1	Check Sum
0xAA	0xFF		3	'N'	0x5C	ERR	

ERR : Error code that shows what occurred error is

- Safety Lock

- Function

Personal Computer turns Safety Lock function of TV / Monitor ON / OFF.

Can operate regardless of whether power is ON / OFF.

- Get Safety Lock Status

Header	command	ID	DATA Length	CheckSum
0xAA	0x5D		0	

- Set Safety Lock Enable / Disable

Header	command	ID	DATA Length	DATA	CheckSum
0xAA	0x5D		1	Safety Lock	

Safety Lock : Lock code to be set on TV / Monitor

1 : ON

0 : OFF

- Ack

Header	com-mand	ID	DATA Length	Ack/Nak	r-CMD	Val1	Check Sum
0xAA	0xFF		3	'A'	0x5D	Safety Lock	

Safety Lock : Same as above

- Nak

Header	com-mand	ID	DATA Length	Ack/Nak	r-CMD	Val1	Check Sum
0xAA	0xFF		3	'N'	0x5D	Safety Lock	

ERR : Error code that shows what occurred error is

Connections

Connecting a Computer

The color and the appearance may differ depending on the product, and the specifications are subject to change without prior notice to improve the performance.

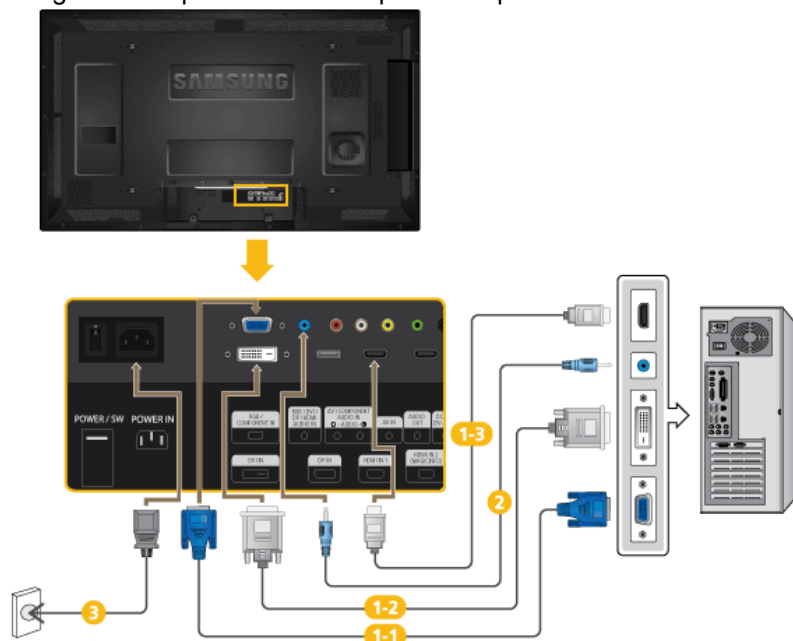

- 1 There are several ways to connect the computer to the monitor. Choose one from the following options.

1-1 Using the D-sub (Analog) connector on the video card.

- Connect the D-sub to the 15-pin, *[RGB/COMPONENT IN]* port on the back of your LCD Display and the 15 pin D-sub Port on the computer.



1-2 Using the DVI (Digital) connector on the video card.

- Connect the DVI Cable to the *[DVI IN]* port on the back of your LCD Display and the DVI port on the computer.



1-3 Using the D-sub (Digital) connector on the video card.

- Connect the [HDMI IN 1] / [HDMI IN 2] port on the LCD Display to the HDMI port on the PC using the HDMI cable.



 **Note**

Select **HDMI2** or **HDMI1** as an input source when connected to the PC via an HDMI cable.

To obtain normal picture and audio from the PC, **HDMI2** or **HDMI1** must be selected before **PC** is selected in **Edit Name**.

To enable audio when **DVI Device** is selected, be sure to establish the connection using step (**2**).

- 2** Connect the Audio cable for your LCD Display to the AUDIO port on the back of the LCD Display.
- 3** Connect the power cord for your LCD Display to the POWER port on the back of the LCD Display. Turn on the power switch.

 **Note**

Contact a local SAMSUNG Electronics Service Center to buy optional items.

Connecting to Other devices

 **Note**

- AV input devices such as DVD players, VCRs or camcorders as well as your computer can be connected to the LCD Display. For detailed information on connecting AV input devices, refer to the contents under Adjusting Your LCD Display.
- The LCD Display 's configuration at the back may vary slightly depending on the LCD Display model.

Connecting AV Devices

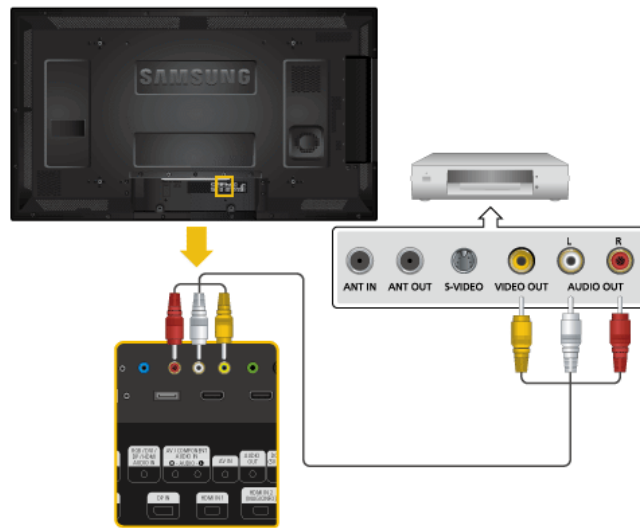

1. Connect an audio cable to *[AV/COMPONENT AUDIO IN [R-AUDIO-L]]* on the product and the audio port on an external device such as a VCR or DVD player.
2. Connect a video cable to *[AV IN]* on the product and the video output port on the external device.
3. Then, start the DVD, VCR or Camcorders with a DVD disc or tape inserted.
4. Press *SOURCE* on the product or remote control and select **AV**.

Connecting to a Camcorder

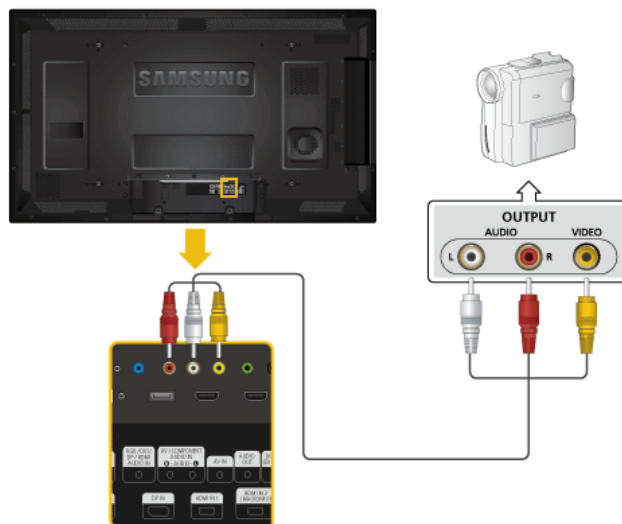

1. Locate the AV output jacks on the camcorder. They are usually found on the side or back of the camcorder. Connect a video cable between the VIDEO OUTPUT jack on the camcorder and the *[AV IN]* on the LCD Display .

2. Connect a set of audio cables between the AUDIO OUTPUT jacks on the camcorder and the [AV /COMPONENT AUDIO IN [R-AUDIO-L]] on the LCD Display .
3. Press *SOURCE* on the product or remote control and select "**AV**".
4. Then, start the Camcorders with a tape inserted.

 **Note**

The audio-video cables shown here are usually included with a Camcorder.

(If not, check your local electronics store.)

If your camcorder is stereo, you need to connect a set of two cables.

Connecting Using a HDMI Cable



1. Connect an HDMI cable to [HDMI IN 2 (MAGICINFO)] or [HDMI IN 1] on the product and the HDMI output port on a digital device.
2. Press *SOURCE* on the product or remote control and select "**HDMI1 / HDMI2**".

 **Note**

In **HDMI** mode, only PCM format audio is supported.

Connecting Using a DVI to HDMI Cable

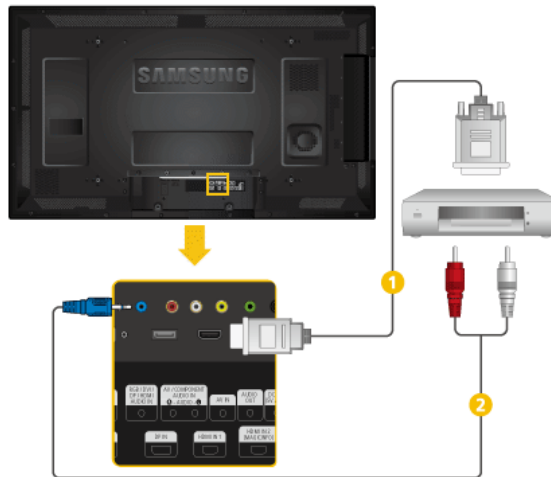

- 1 Connect a DVI-HDMI cable to *[HDMI IN 2 (MAGICINFO)]* or *[HDMI IN 1]* and the DVI output port on the digital device.
- 2 Connect the red and white jacks of an RCA to stereo (for PC) cable to the same colored audio output terminals of the digital output device, and connect the opposite jack to the *[RGB/DVI/DP/HDMI AUDIO IN]* terminal of the LCD Display.
3. Press *SOURCE* on the product or remote control and select "**HDMI1 / HDMI2**"

Connecting a DVD Player

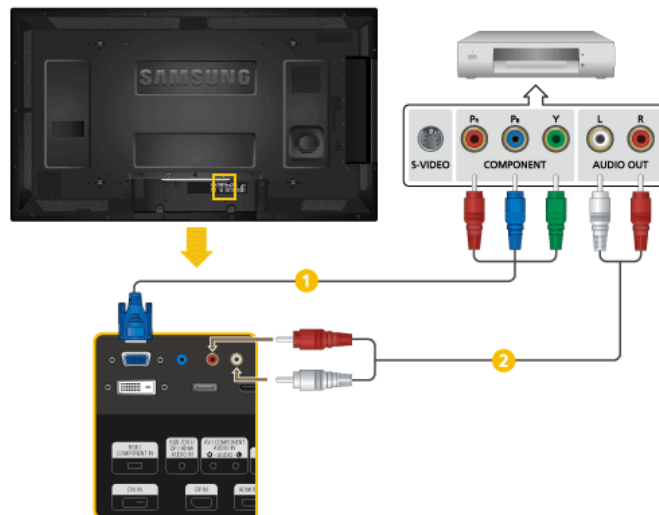

- 1 Connect a RGB to Component cable between the *[RGB/COMPONENT IN]* port on the LCD Display and the P_R , Y, P_B jacks on the DVD player.
- 2 Connect a set of audio cables between the *[AV/COMPONENT AUDIO IN [R-AUDIO-L]]* on the LCD Display and the AUDIO OUT jacks on the DVD player.

 **Note**

- Press *SOURCE* on the product or remote control and select "**Component**".
- Then, start the DVD Player with a DVD disc inserted.
- A RGB to component cable is optional.
- For an explanation of Component video, consult your DVD manual.

Connecting a DTV Set Top (Cable/Satellite) Box

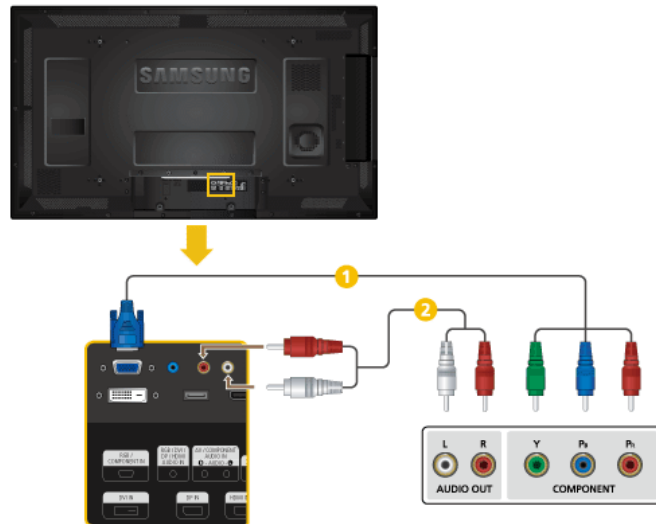

- 1 Connect a RGB to Component cable between the *[RGB/COMPONENT IN]* port on the LCD Display and the P_R, Y, P_B jacks on the Set Top Box.
- 2 Connect a set of audio cables between the *[AV/COMPONENT AUDIO IN [R-AUDIO-L]]* on the LCD Display and the AUDIO OUT jacks on the Set Top Box.

 **Note**

- Press *SOURCE* on the product or remote control and select "**Component**".
 - For an explanation of Component video, see your Set Top Box owner's manual.
-

Connecting to an Audio System

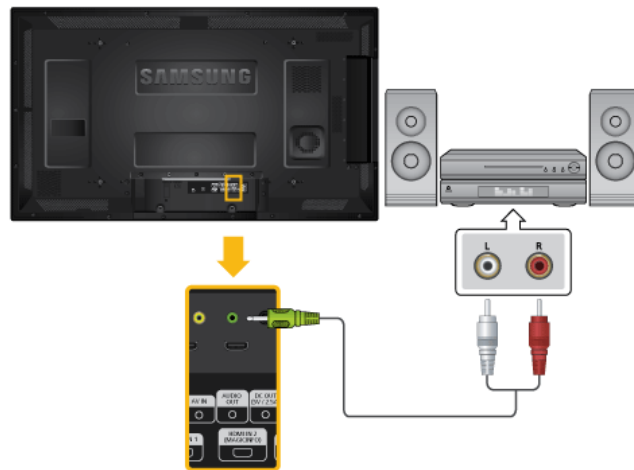

1. Connect a set of audio cables between the AUX L, R jacks on the AUDIO SYSTEM and [AUDIO OUT] on LCD Display.

Connecting a Network Box (sold separately)



- Network boxes are sold separately.
- For more information on how to purchase and install a network box, contact Samsung Electronics.

Connecting the Power

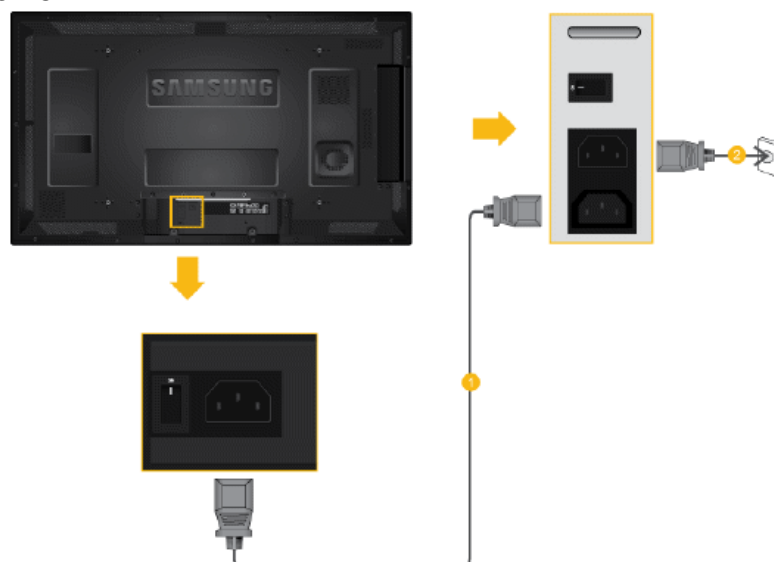

- 1 Connect the [POWER] terminal of the product and the [POWER] terminal of the installed network box using a power extension cable.
- 2 Connect the power cord to [POWER] on the network box and mains socket.

Turn on the power switch.

Connecting to MAGICINFO OUT

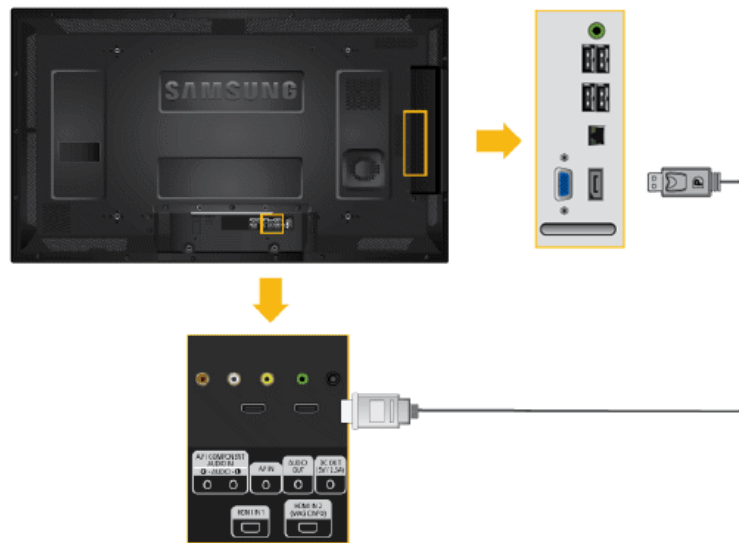

Connect the [MAGICINFO OUT] terminal of the network box and the [HDMI IN 2 (MAGICINFO)] terminal of the monitor using the **DP to HDMI** cable.

Connecting a LAN Cable

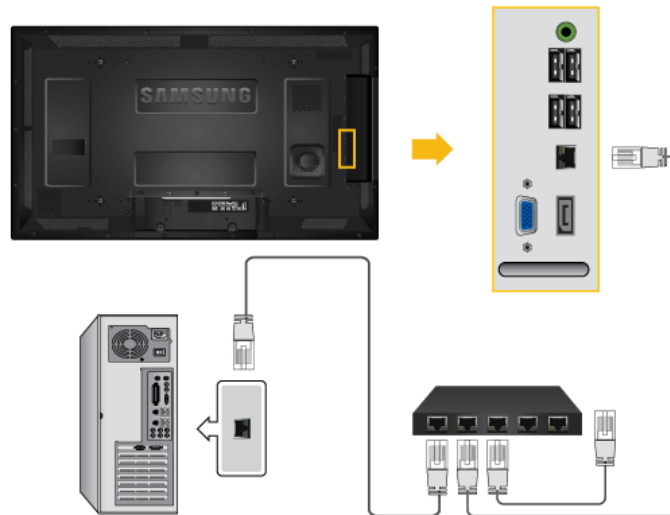

Connect the LAN cable between the [LAN] port on the product and the [LAN] port on your PC.

Connecting a USB devices

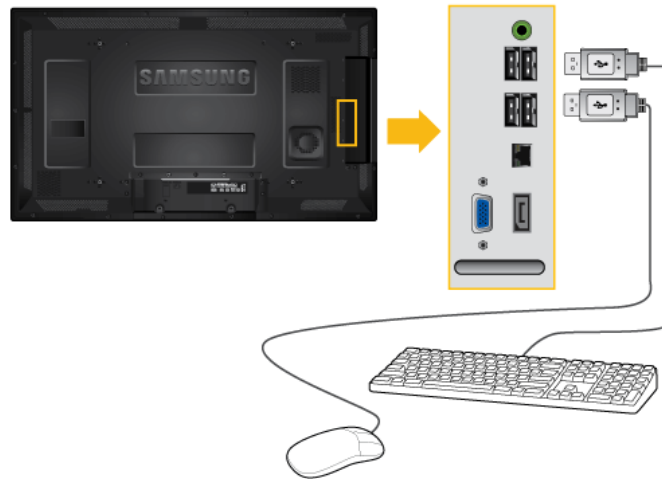

You can connect USB devices such as a mouse or keyboard.

Using the Software

Monitor Driver



Note

When prompted by the operating system for the monitor driver, insert the CD-ROM included with this monitor. Driver installation is slightly different from one operating system to another. Follow the directions appropriate for the operating system you have.

Prepare a blank disk and download the driver Program file at the Internet web site shown here.

Internet web site :

<http://www.samsung.com/>

Installing the Monitor Driver (Automatic)

1. Insert CD into the CD-ROM drive.
2. Click "Windows".
3. Choose your monitor model in the model list, then click the "OK" button.

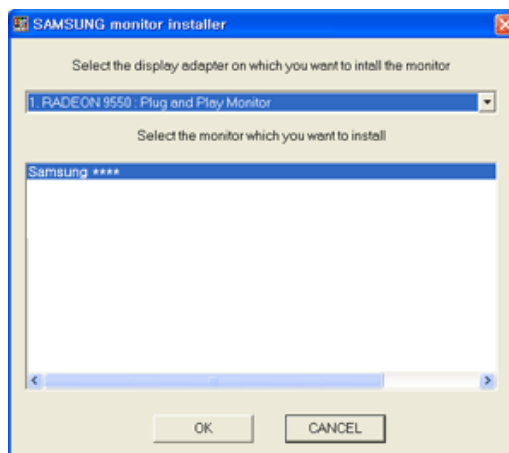

4. If you can see following message window, then click the "Continue Anyway" button. Then click "OK" button (Microsoft® Windows® XP/2000 Operating System).





Note

This monitor driver is certified by Microsoft, and installing it will not damage your system.

The certified driver will be posted on Samsung Monitor homepage.

<http://www.samsung.com/>

Installing the Monitor Driver (Manual)

Microsoft® Windows Vista™, Operating System

1. Insert your Manual CD into your CD-ROM drive.
2. Click  (Start) and "Control Panel". Then, double-click on "Appearance and Personalization".



3. Click "Personalization" and then "Display Settings".



4. Click "Advanced Settings...".

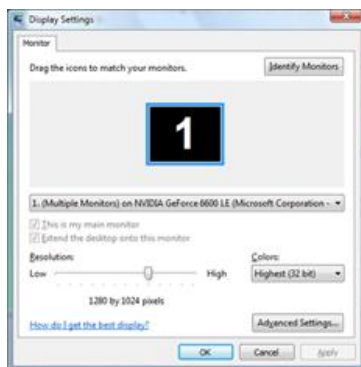

5. Click "Properties" in the "Monitor" tab. If the "Properties" button is deactivated, it means the configuration for your monitor is completed. The monitor can be used as is.

If the message "Windows needs..." is displayed, as shown in the figure below, click "Continue".



 **Note**

This monitor driver is under certifying MS logo, and this installation will not damage your system.

The certified driver will be posted on Samsung Monitor homepage.

6. Click "Update Driver..." in the "Driver" tab.

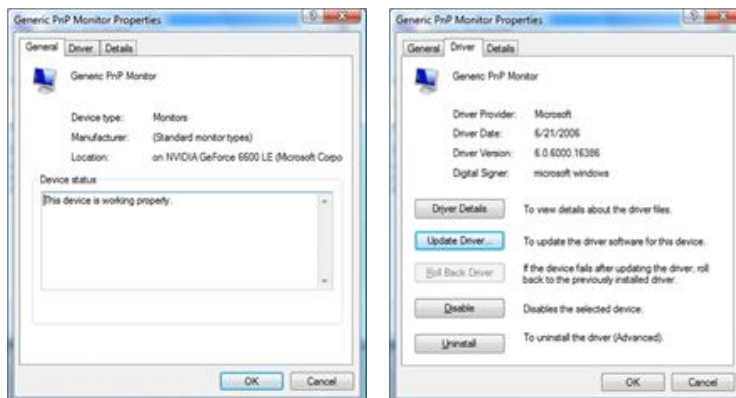

7. Check the "Browse my computer for driver software" checkbox and click "Let me pick from a list of device drivers on my computer".

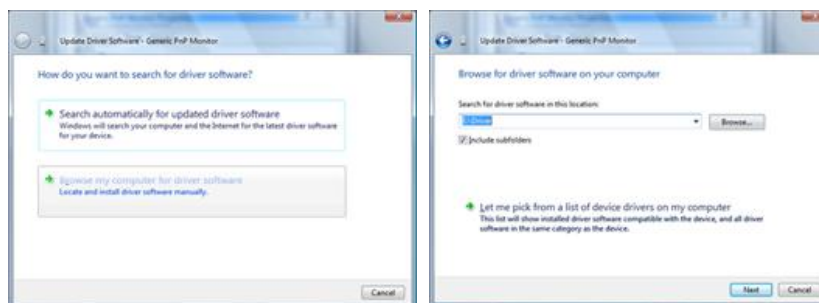

8. Click "Have Disk..." and select the folder (for example, D:\Drive) where the driver setup file is located, and click "OK".

Using the Software

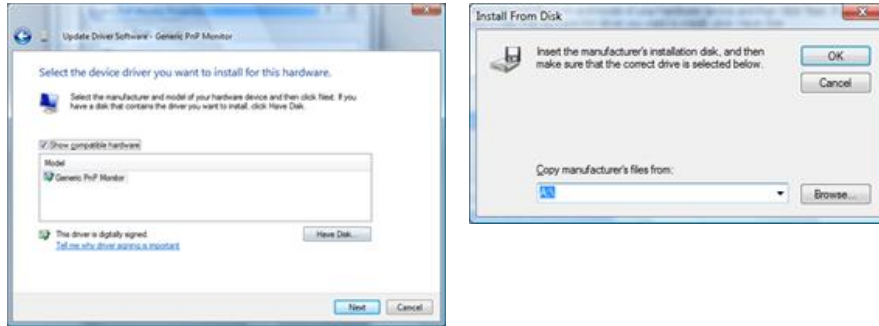

9. Select the model that matches your monitor from the list of monitor models on the screen, and click "Next".

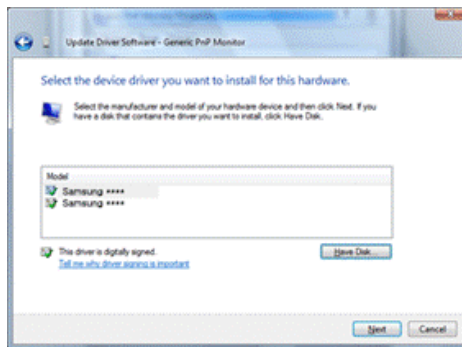

10. Click "Close" → "Close" → "OK" → "OK" on the following screens displayed in sequence.

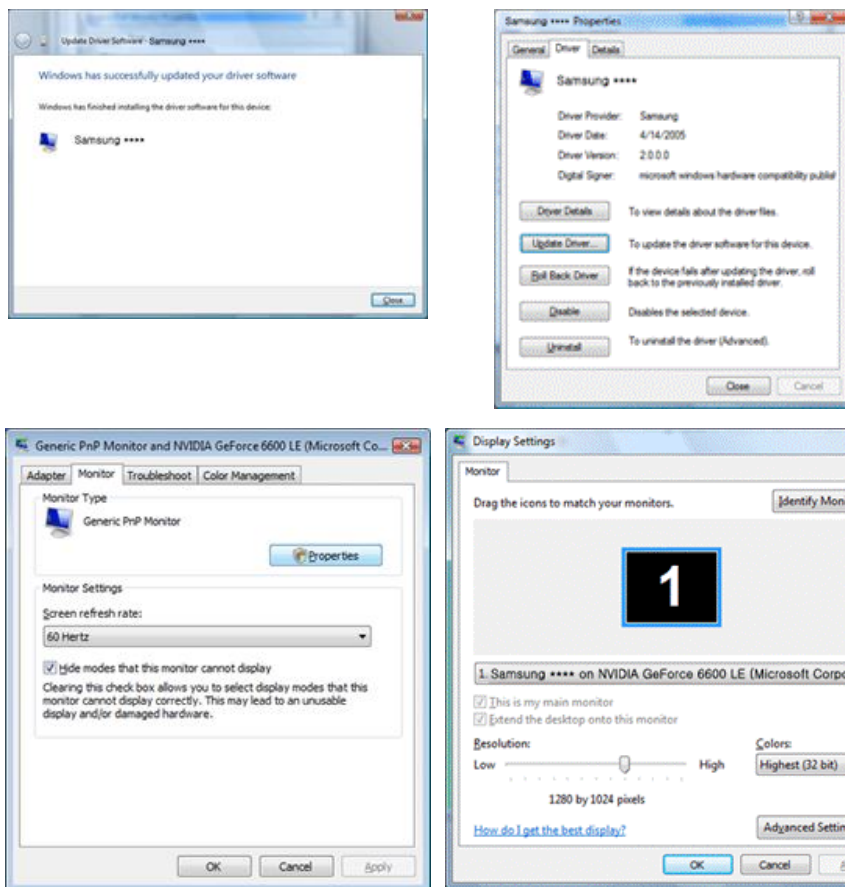

Using the Software

1. Insert CD into the CD-ROM drive.
2. Click "Start" → "Control Panel", then click the "Appearance and Themes" icon.

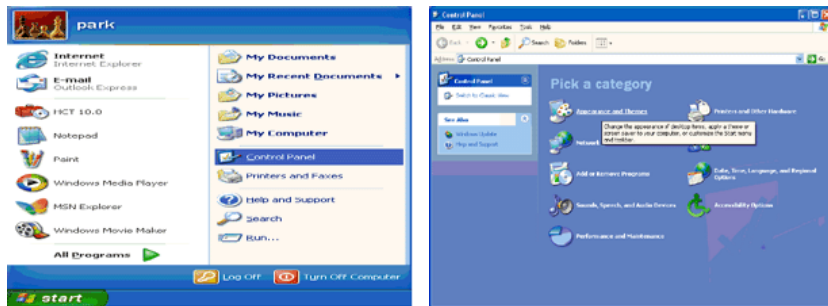

3. Click "Display" icon and choose the "Settings" tab then click "Advanced...".

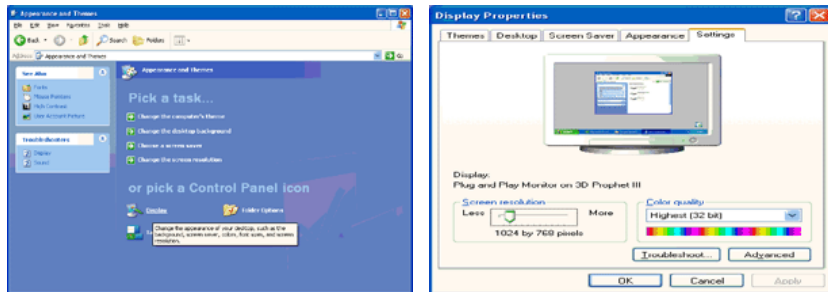

4. Click the "Properties" button on the "Monitor" tab and select "Driver" tab.

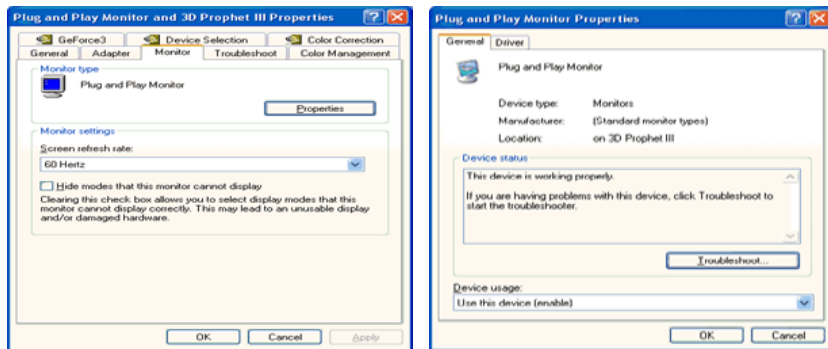

5. Click "Update Driver..." and select "Install from a list or..." then click "Next" button.

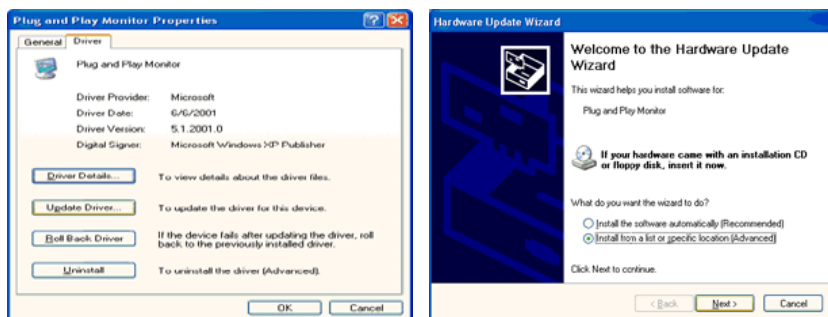

6. Select "Don't search, I will...", then click "Next" and then click "Have disk".

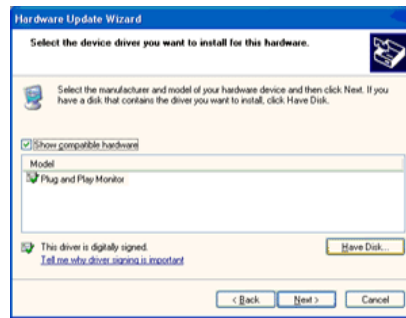
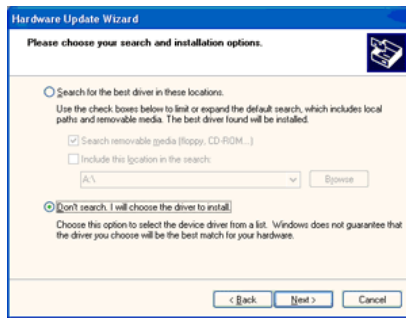

7. Click the "Browse" button then choose A:(D:\Driver) and choose your monitor model in the model list and click the "Next" button.

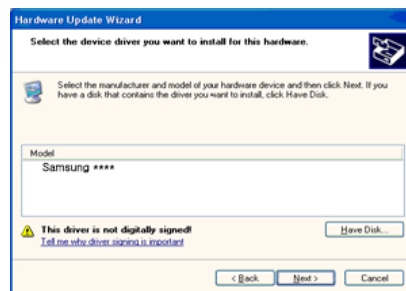
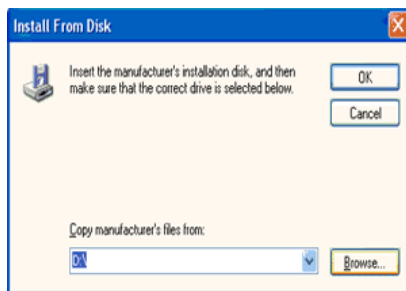

8. If you can see the following message window, then click the "Continue Anyway" button. Then click "OK" button.



 **Note**

This monitor driver is certified by Microsoft, and this installation will not damage your system.

The certified driver will be posted on Samsung Monitor homepage.

<http://www.samsung.com/>

9. Click the "Close" button, then click the "OK" button continually.

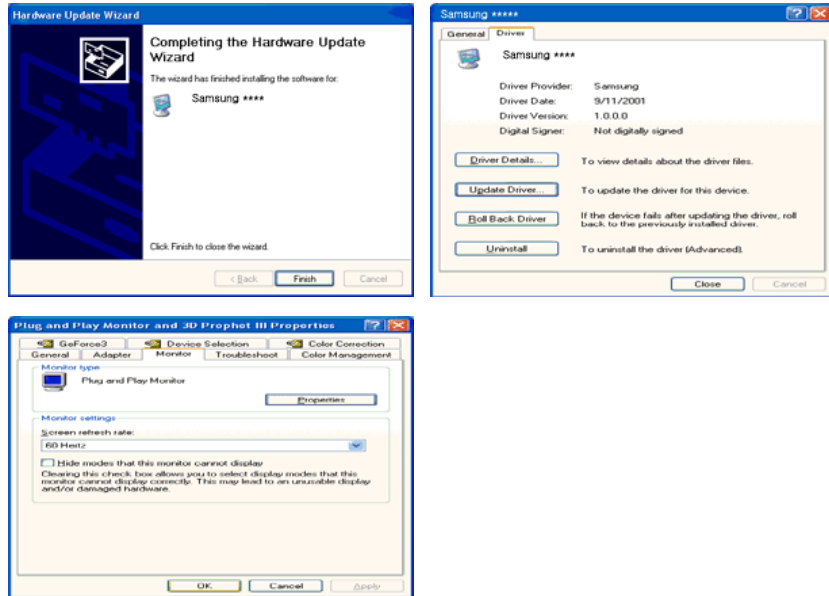

10. Monitor driver installation is completed.

Microsoft® Windows® 2000 Operating System

When you can see "Digital Signature Not Found" on your monitor, follow these steps.

1. Choose "OK" button on the "Insert disk" window.
2. Click the "Browse" button on the "File Needed" window.
3. Choose A:(D:\Driver), then click the "Open" button and then click "OK" button.

How to install

1. Click "Start", "Setting", "Control Panel".
2. Double click the "Display" icon.
3. Select the "Settings" tab and click "Advanced Properties" button.
4. Choose "Monitor".

Case1 : If the "Properties" button is inactive, it means your monitor is properly configured. Please stop installation

Case2 : If the "Properties" button is active, click the "Properties" button, then follow the next steps.

5. Click "Driver" and then click on "Update Driver...", then click on the "Next" button.
6. Choose "Display a list of the known drivers for this device so that I can choose a specific driver", then click "Next" and then click "Have disk".
7. Click the "Browse" button, then choose A:(D:\Driver).
8. Click the "Open" button, then click "OK" button.
9. Choose your monitor model and click the "Next" button. Then click "Next" button.
10. Click the "Finish" button, then the "Close" button.

If you can see the "Digital Signature Not Found" window, then click the "Yes" button. Then click the "Finish" button and the "Close" button.

Microsoft® Windows® Millennium Operating System

1. Click "Start", "Setting", "Control Panel".
2. Double click the "Display" icon.
3. Select the "Settings" tab and click "Advanced Properties" button.
4. Select the "Monitor" tab.
5. Click the "Change" button in the "Monitor Type" area.
6. Choose "Specify the location of the driver".
7. Choose "Display a list of all the driver in a specific location...", then click "Next" button.
8. Click the "Have Disk" button.
9. Specify A:\(D:\driver), then click "OK" button.
10. Select "Show all devices" and choose the monitor that corresponds to the one you connected to your computer and click "OK".
11. Continue choosing "Close" button and "OK" button until you close the Display Properties dialogue box.

Microsoft® Windows® NT Operating System

1. Click "Start", "Settings", "Control Panel", and then double-click "Display" icon.
2. In Display Registration Information window, click Settings Tab and then click "All Display Modes".
3. Select a mode that you wish to use (Resolution, Number of Colors and Vertical frequency) and then click "OK".
4. Click "Apply" button if you see the screen working normally after clicking "Test". If the screen is not normal, change to a different mode (lower mode of resolution, Colors or frequency).



Note

If there is no Mode at All Display Modes, select the level of resolution and vertical frequency by referring to the Preset Timing Modes in the user guide.

Linux Operating System





To execute X-Window, you need to make the X86Config file, which is a type of system setting file.

1. Press "Enter" at the first and the second screen after executing the X86Config file.
 2. The third screen is for setting your mouse.
 3. Set a mouse for your computer.
 4. The next screen is for selecting a keyboard.
-

5. Set a Keyboard for your computer.
6. The next screen is for setting your monitor.
7. First of all, set a horizontal frequency for your monitor. (You can enter the frequency directly.)
8. Set a vertical frequency for your monitor. (You can enter the frequency directly.)
9. Enter the model name of your monitor. This information will not affect the actual execution of X-Window.
10. You have finished setting up your monitor. Execute X-Window after setting other requested hardware.

MDC Program Installation/Uninstallation

Installation

- 1 Insert the installation CD into the CD-ROM drive.
- 2 Click the **MDC Unified** installation program.
 -  If a software installation window is not displayed on the main screen, install with the "MDC Unified" execution file in the MDC folder on the CD.
- 3 Click "Next" in the displayed Installation Wizard screen.
- 4 In the "License Agreement" window displayed, select "I accept the terms in the license agreement" and click "Next".
- 5 In the displayed "Customer Information" window, fill out all the information fields and click "Next".
- 6 In the displayed "Destination Folder" window, select the directory path you want to install the program in and click "Next".
 -  If the directory path is not specified, the program will be installed in the default directory path.
- 7 In the displayed "Ready to Install the Program" window, check the directory path to install the program in and click "Install".
- 8 Installation progress will be displayed.
- 9 Click "Finish" in the displayed "InstallShield Wizard Complete" window.
 -  Select "Launch MDC Unified" and click "Finish" to run the MDC program immediately.
- 10 The MDC Unified shortcut icon will be created on the desktop after installation.
 - 
 - The MDC execution icon may not be displayed depending on the PC system or product specifications.
 - Press F5 if the execution icon is not displayed.

Uninstallation

- 1 Select **Settings > Control Panel** on the **Start** menu and double-click **Add/Delete Program**.
 - 2 Select **MDC Unified** from the list and click **Change/Remove**.
-  MDC installation can be affected by the graphics card, mother board and network conditions.

What is MDC?

Multiple display control "MDC" is an application that allows you to easily control multiple display devices simultaneously using a PC.

Connecting to MDC

Using MDC via RS-232C (serial data communications standards)

An RS-232C serial cable must be connected to the serial ports on the PC and monitor.

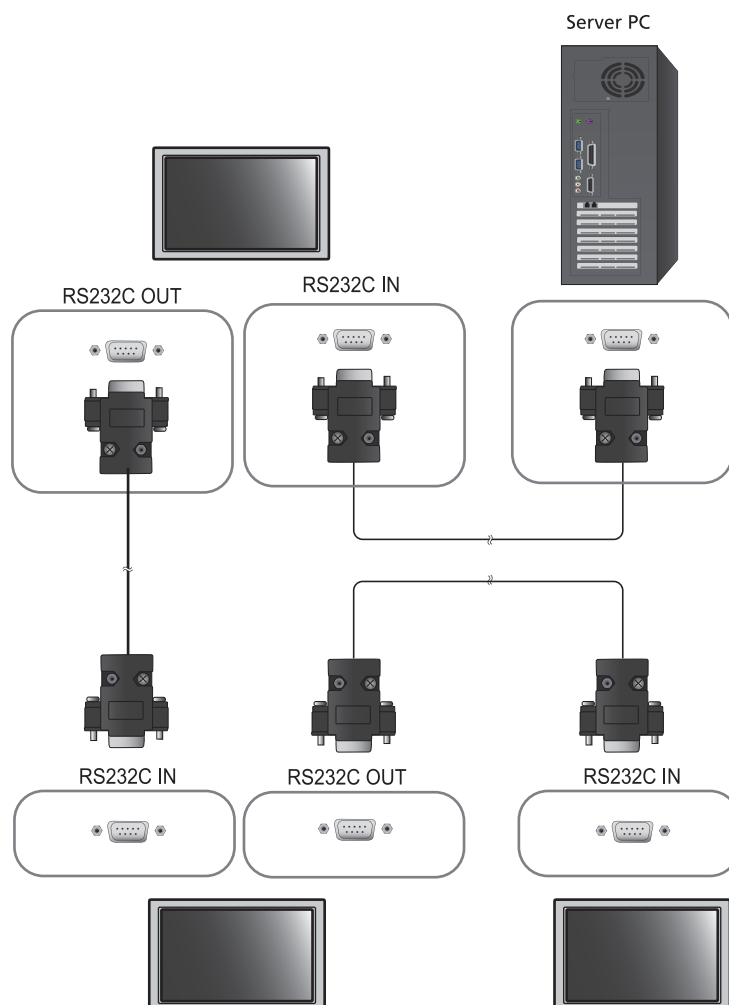

Using MDC via Ethernet

Enter the IP for the primary display device and connect the device to the PC. One display device can connect to another using an RS-232C serial cable.

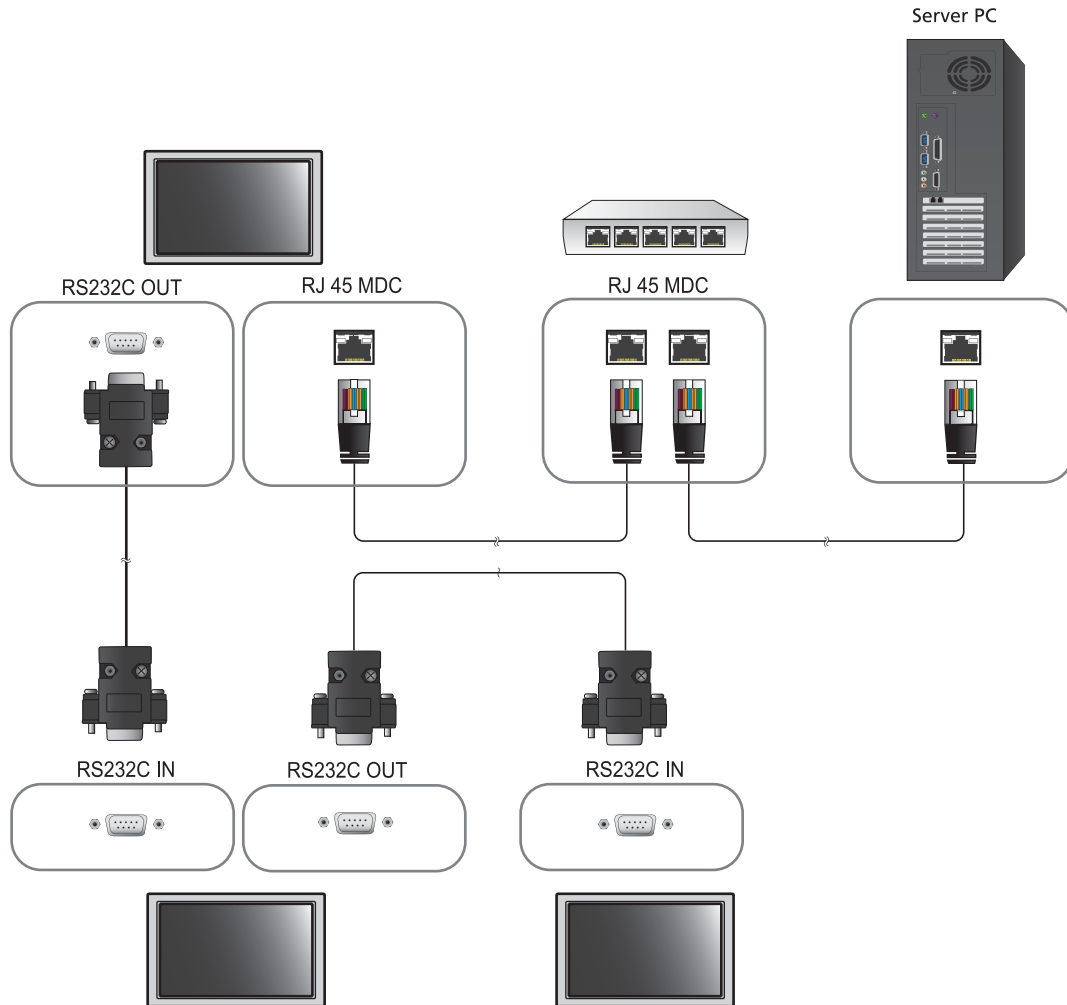

Connection Management

Connection management includes the **Connection list** and **Connection list modification options**.

Connection list – Connection list shows the details of the connections such as connection setting (IP/COM, Port No, MAC, and **Connection Type**), connection status, **Set ID Range**, and detected devices. Each connection can contain a maximum of 100 devices connected in serial daisy-chain fashion. All the LFDs detected in a connection are displayed in the Device list, where the user can make groups and send commands to detected devices.

Connection list modification options – Connection modification options includes **Add**, **Edit**, **Delete**, and **Refresh**.

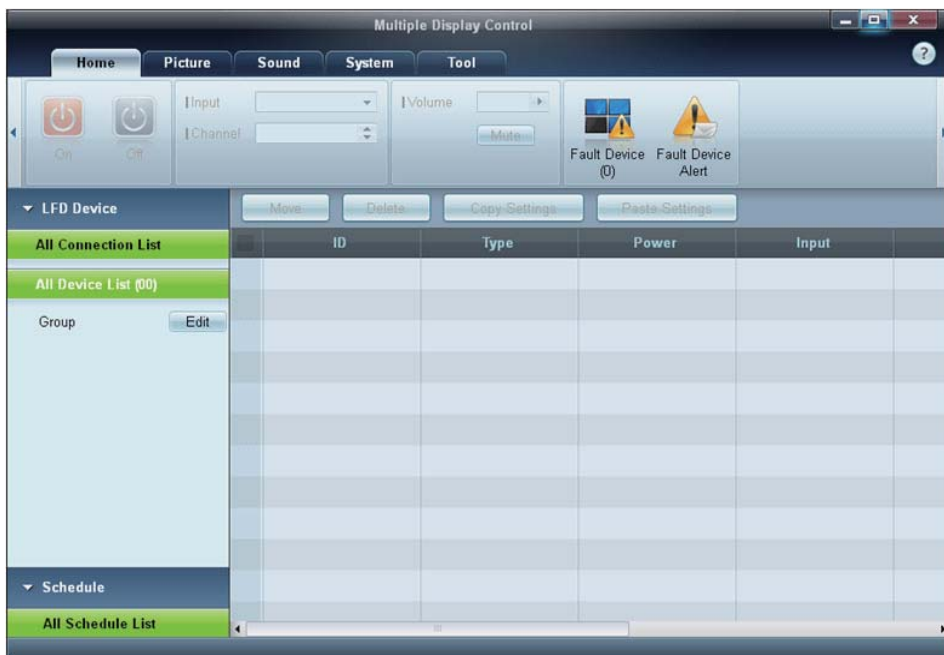

Auto Set ID

Auto Set ID feature assigns a Set ID for all the LFDs connected in daisy-chain of a selected connection. There can be a maximum of 100 LFDs in a connection. The Set ID is assigned sequentially in the daisy-chain running from 1 to 99, and then finally to Set ID 0.

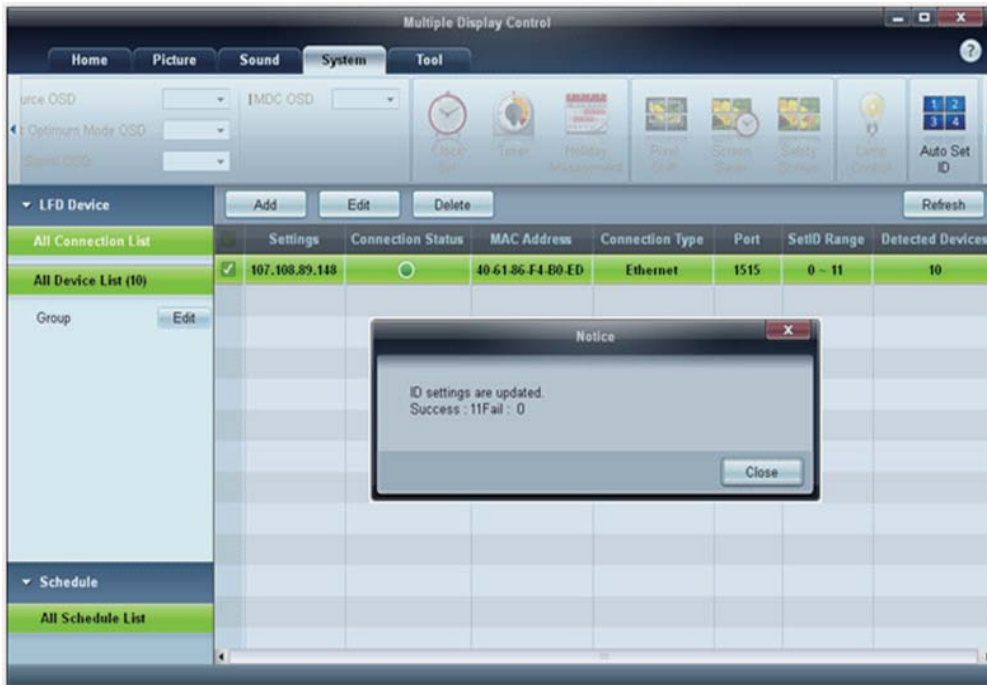

Cloning

Using the Cloning feature, you can copy the setting of one LFD and apply it to multiple selected LFDs. You can select specific tab categories or all tab categories for cloning, using the copy setting option window.

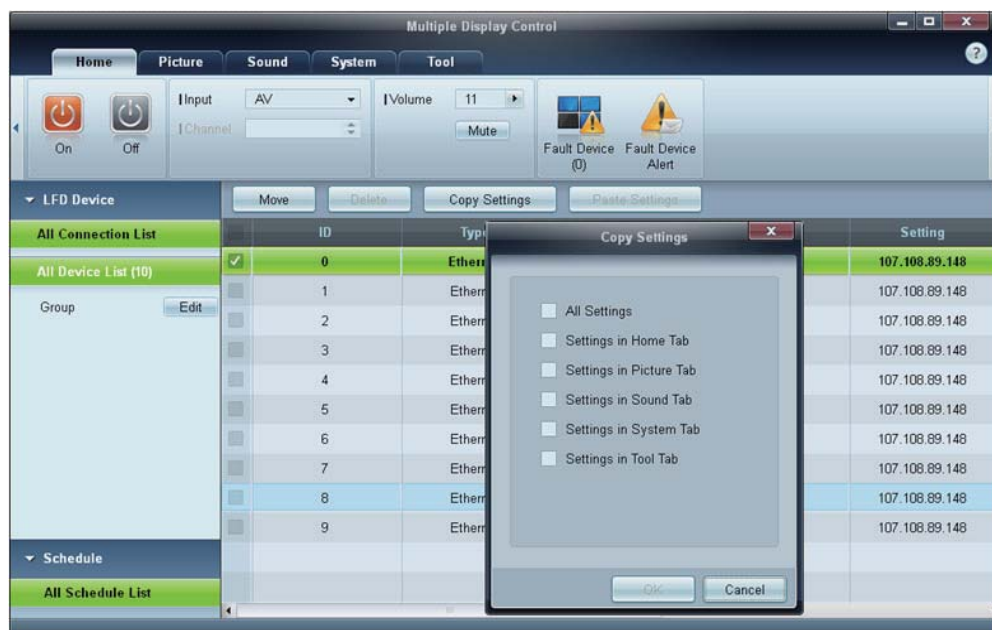

Command Retry

This feature is used to specify the maximum number of times the MDC command will be retried in case of there being no reply or a corrupted reply from an LFD. The retry count value can be set using the MDC options window. The retry count value must be between 1-10. The default value is 1.

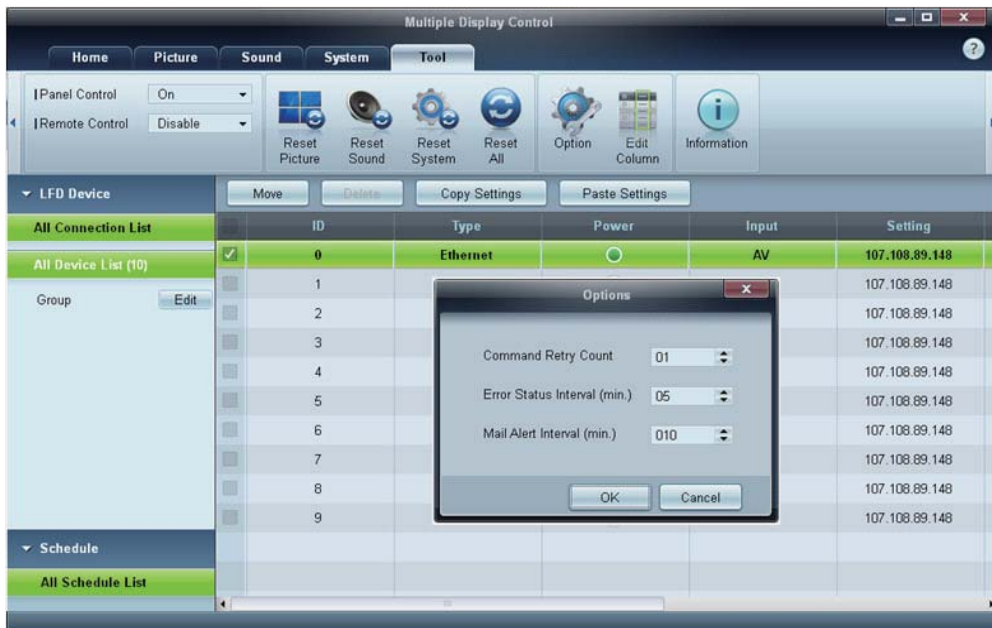

Getting Started with MDC

- 1 To start the program, click **Start** → **Programs** → **Samsung** → **MDC Unified**.

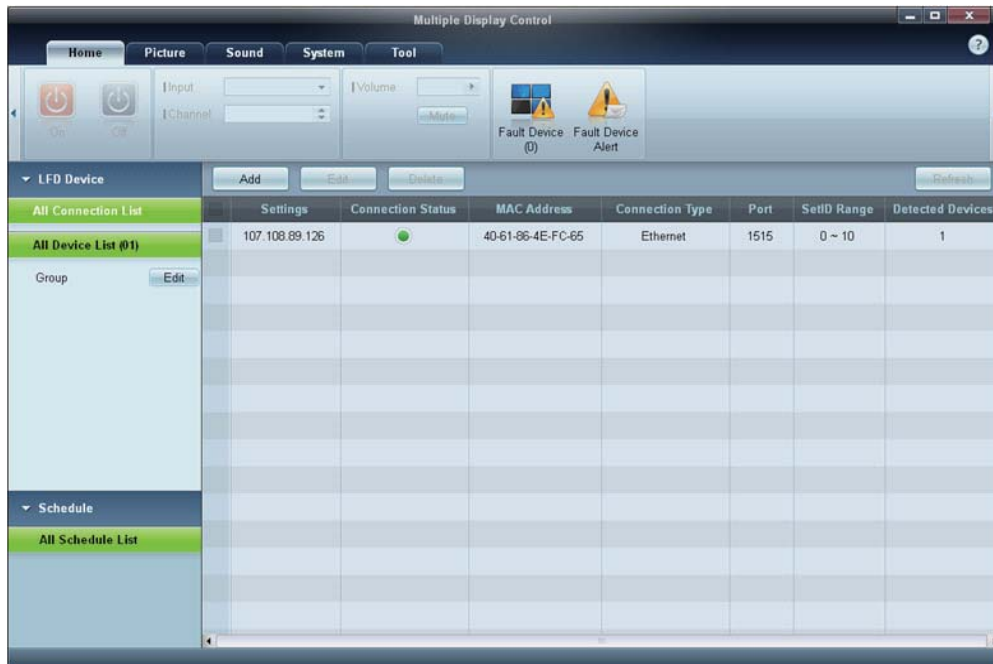

- 2 Click **Add** to add a display device.
 - If the connection is established via RS232C, go to **Serial** and specify the **COM Port**.

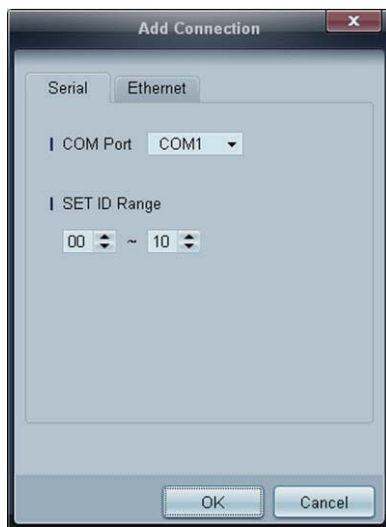

- If the connection is established via **Ethernet**, enter the IP that was entered for the display device.

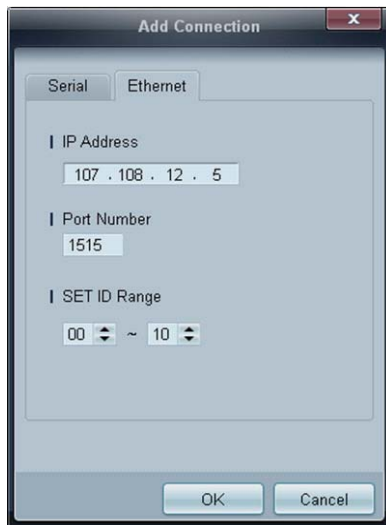

The image shows a software dialog box titled "Add Connection" with a close button (X) in the top right corner. It has two tabs: "Serial" and "Ethernet", with "Ethernet" selected. The dialog contains three sections:

- IP Address:** A text input field containing "107 . 108 . 12 . 5".
- Port Number:** A text input field containing "1515".
- SET ID Range:** Two spinners with a tilde (~) between them, showing "00" and "10".

At the bottom of the dialog are two buttons: "OK" and "Cancel".

Main Screen Layout

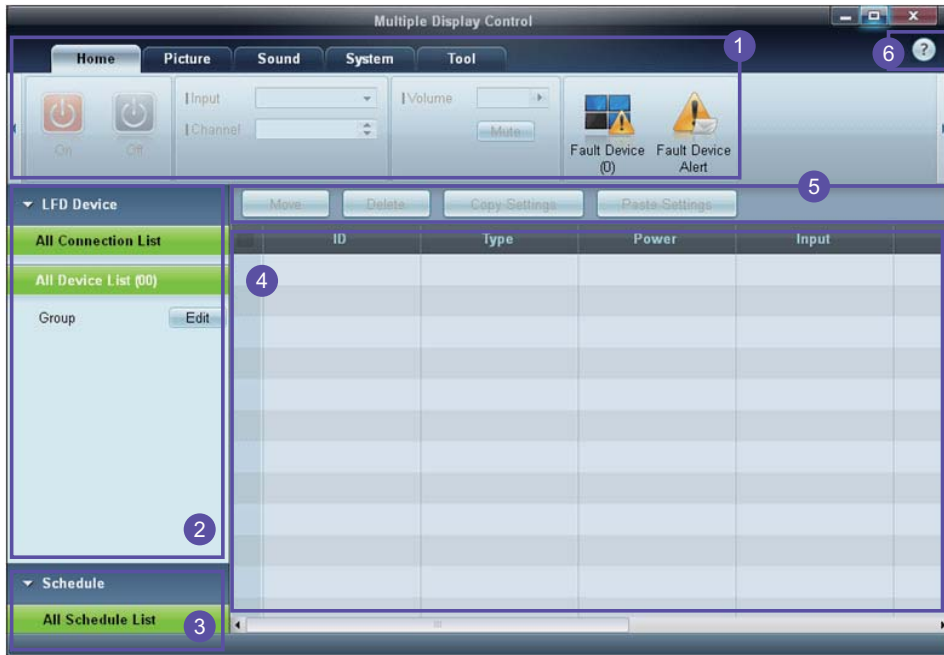

1	Menu Bar	Change the status of a display device or the properties of the program.
2	Device Category	View a list of connected display devices or device groups.
3	Schedule Category	View a list of schedules for display devices.
4	Set List	Select the display device you want to adjust.
5	Modify the Set List	Add, edit, regroup or delete sets.
6	Help Topics	Display help topics for the program.

Menus

You can power on or off a selected device or change the input source or volume of the device.

Choose display devices from the list of sets, and select the **Home** tab.





1 Home

Select an item and change the corresponding setting.

Power

- **On:** Power on a selected display.
- **Off:** Power off a selected display.

Input

- Input Source : Change the input source.
 -  Input sources available can vary depending on the Display Device Models.
 - The input source can be changed only for displays that are turned on.
- **Channel** : Change the channel.
 -  The TV channel can be changed by using the up/down arrow keys.
 - The channel can be changed only when the input source is **TV**.
 - Only registered channels can be selected.

2 Volume

-  The volume can be changed or the sound can be muted only for displays that are turned on.

Volume

- The volume can be adjusted using the slider bar in the range of 0 to 100.
Adjust the volume of a selected display.

Input

- Enable or disable **Mute** for a selected display.
Mute will automatically be disabled if **Volume** is adjusted when **Mute** is on.

3 Alert

- **Fault Device**

- This menu shows a list of display devices which have following errors - fan error, temperature error, brightness sensor error, or lamp error.

Select a display device from the list. The **Repair** button will be enabled. Click the refresh button to refresh the error status of the display device. The recovered display device will disappear from the **Fault Device List**.

Fault Device Alert

- Display device in which error is detected will be reported by email.

Fill in all required fields. The **Test** and **OK** buttons will be enabled. Ensure the **Sender** information and at least one **Recipient** are entered.

Screen Adjustment

The screen settings (contrast, brightness, etc.) can be adjusted.

Choose display devices from the list of sets, and select the **Picture** tab.

Custom

Select an item and change the corresponding screen setting.



- **Color** and **Tint** are not available if the input source is **PC**.
- **Red**, **Green**, **Blue** and **PC Screen Adjustment** are not available if the input source is **Video**.
- **Color**, **Tint**, **Color Tone**, **Color Temp**, **Red**, **Green**, **Blue** and **PC Screen Adjustment** are not available if both **PC Source** and **Video Source** are selected.

Contrast

- Adjust the contrast for the selected display device.

Brightness

- Adjust the brightness for the selected display device.

Color

- Adjust the colors for the selected display device.

Tint (G/R)

- Adjust the tint for the selected display device.

Color Tone

- Adjust the background color tone for the selected display device.

Color Temp

- Adjust the color temperature for the selected display device.



This option is enabled if **Color Tone** is set to **Off**.

Red

- Customize the intensity of red color for the selected display device.

Green

- Customize the intensity of green color for the selected display device.

Blue

- Customize the intensity of blue color for the selected display device.

Options



Dynamic Contrast

Adjust the **Dynamic Contrast** for the selected display device.

Gamma Control

Change the gamma value for the selected display.

Auto Motion Plus

This option is used to view dynamic images.

- **Off:** Disable the **Auto Motion Plus** function.
- **Clear:** Set the level of **Auto Motion Plus** to clear. This mode is suitable to display vivid images.
- **Standard:** Set the level of **Auto Motion Plus** to standard.
- **Smooth:** Set the level of **Auto Motion Plus** to smooth. This mode is suitable to display smooth images.
- **Custom:** Customize the level of screen burn-in or flickering.
- **Demo:** This function demonstrates the technology of **Auto Motion Plus**. The result when the mode is changed can be previewed on the left side of the window.

Brightness Sensor

Enable or disable the **Brightness Sensor** for the selected display device.

The **Brightness Sensor** detects the ambient light intensity and automatically adjusts the screen brightness.



Brightness Sensor may not be available depending on the product.

Size



Picture Size

Adjust the screen size for the selected display device.

The **Detail** item will be disabled if **Picture Size** is set to a mode that does not support detailed configuration.

The -/+ buttons can be used to adjust **Zoom**.

The screen can be relocated using the up/down/left/right buttons.

Detail

You can view details of the selected screen size.

PC Screen Adjustment

Frequency adjustment or fine-tuning is available by using the -/+ buttons in **Coarse** or **Fine**.

To relocate the screen, click one of the four images below **Position**.

To automatically adjust the frequency, fine-tune or relocate the screen, click **Auto Adjustment**.

Sound Adjustment

You can change the sound settings.

Choose display devices from the list of sets, and select the **Sound** tab.



The **Bass** or **Treble** item will be disabled if the item is not supported by the selected set.

Bass

Adjust the bass for the selected display.

Treble

Adjust the treble for the selected display.

Balance (L/R)

Adjust the volume of the left and right speakers of the selected display device.

SRS TS XT

Enable or disable the **SRS TS XT** effect for the selected display device.

System Setup

Choose display devices from the list of sets, and select the **System** tab.

Video Wall

The **Video Wall** function can be used to display part of a whole picture or repeat the same picture on each of connected multiple display devices.



Video Wall is enabled only when devices are in the group.



Video Wall

Enable or disable **Video Wall**.

Format

Select the format to display the split screen.

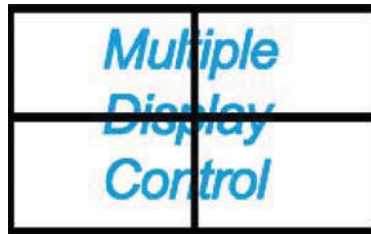
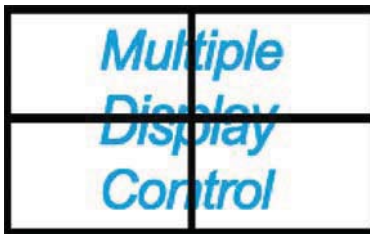

Full



Natural

H

Select the number of horizontal display devices.

A maximum of 15 displays can be arranged in a row.



A maximum of 6 can be assigned to V if 15 is assigned to H.

V

Select the number of vertical display devices.

A maximum of 15 displays can be arranged in a row.



A maximum of 6 can be assigned to V if 15 is assigned to H.

Screen Position

View the layout of displays (configured by the screen divider) or change the layout as required.

Screen Position and **Preview** are enabled when **Video Wall** is set to on.

Note that if multiple sets are selected, **Preview** is enabled only if the settings for H and V match the layout of the selected sets.

To change the **Position**, select a set and drag it to a new position.



The range of screen divider settings may differ depending on the model.

PIP

Basic information required to adjust **PIP** will appear in the menu screen.



- **PIP** will be disabled when **Video Wall** is **ON**.
- Note that **Picture Size** is disabled when **PIP** is **ON**.



PIP Size

View the **PIP Size** of the current display.

PIP Source

Select a PIP input source.

Sound Select

Select and enable the sound from either the primary screen or secondary screen.

Channel

The channel can be changed if **PIP Source** is **TV**.

General



User Auto Color

Automatically adjust the screen colors.



Available only in **PC** mode.

Auto Power

Set the product to automatically power on.

Standby Control

Set the standby mode to activate if an input source is not detected.

Fan & Temperature



Configure the settings required to detect the fan speed and internal temperature for the product's protection.

Fan Control

Select a method to configure the fan speed.

Fan Speed

Configure the fan speed.

Temperature

Detect the internal temperature by specifying the range of temperature.

Security



Safety Lock

Lock the on-screen menus.



To unlock the menus, set **Safety Lock** to **Off**.

Button Lock

Lock the buttons on the display device.



To unlock the buttons, set **Button Lock** to **Off**.

OSD Display



Source OSD

Select whether to display a message when the **Source** is changed.

Not Optimum Mode OSD

Select whether to display a message when a non-compatible mode is selected.

No Signal OSD

Select whether to display a message when there is no input signal.

MDC OSD

Select whether to display a message when settings are changed by the MDC.

Time



Clock Set



Change the current time on the selected display device according to the time set on a PC.

If the time is not set on the display device, null values will be displayed.

Timer

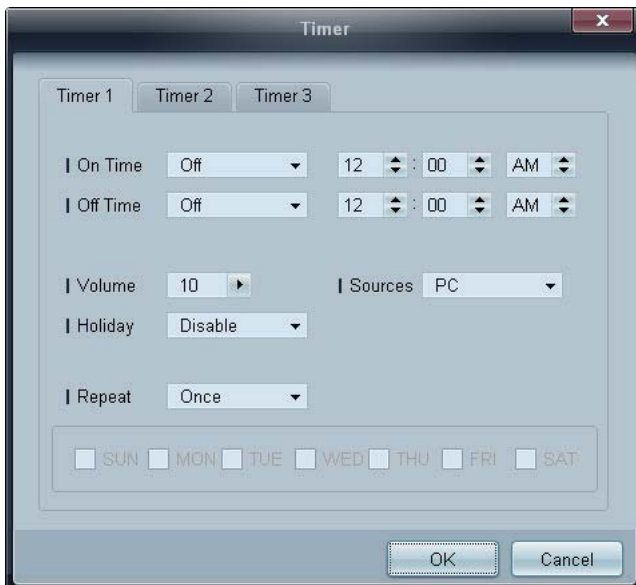

- **On Time:** Set the time to power on the selected display device.
- **Off Time:** Set the time to power off the selected display device.
- **Volume:** Specify the volume of the display device when it is powered on by **On Time**.
- **Source:** Specify the input source of the display device when it is powered on by **On Time**.
- **Holiday:** The **Holiday Management** settings can be applied to the **Timer**.
- **Repeat :** Specify the period for which you want to repeat the selected **Timer**.

- **Once:** Activate the timer only one time.
- **EveryDay:** Activate the timer every day.
- **Mon~Fri:** Activate the timer from Monday through Friday.
- **Mon~Sat:** Activate the timer on Saturdays and Sundays.
- **Manual:** Customize days of the week.

 The checkboxes to select days of the week below **Repeat** are enabled only if **Manual** is selected.

Holiday Management

Holiday Management allows you to prevent devices that are set to be powered on by the **Timer** from turning on at a specified date.

 The **Holiday Management** function can be enabled or disabled in the **Timer** settings menu.

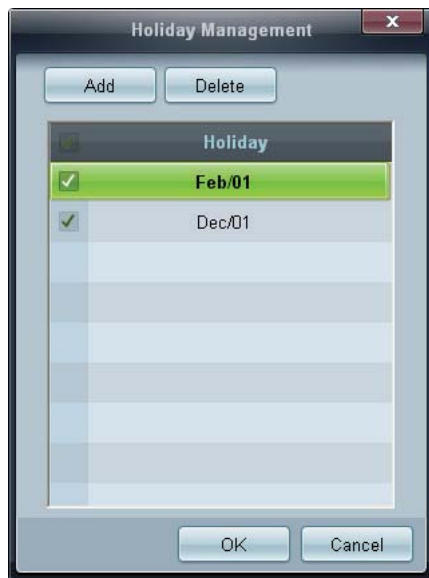

- **Add:** You can specify holidays:
Click the **Add** button in the **Holiday Management** window.



- **Delete:** Delete holidays: check the corresponding checkboxes and click this button.
- List of holidays: View a list of holidays you have added.

Screen Burn Protection

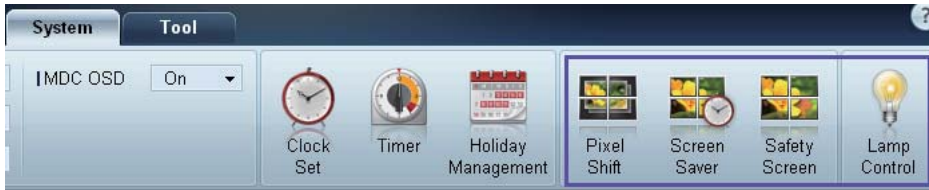

Pixel Shift



Move the screen slightly at specified time intervals to prevent screen burn-in.

Screen Saver



This function prevents screen burn-in when the screen of the selected display device is left idle for an extended period of time.

- **Interval:** Set the interval to activate the **Screen Saver**.
- **Mode:** The **Time** setting can vary for each **Mode**.

Safety Screen



The **Safety Screen** function can be used to prevent screen burn-in when a stationary image displays on the screen of a display device for an extended period of time.

Lamp Control

Lamp Control is used to adjust the backlight to reduce power consumption.



Automatically adjust the backlight of the selected display device at a specified time.

If **Manual Lamp Control** is adjusted, **Auto Lamp Control** will automatically switch to **Off**.

Manually adjust the backlight for the selected display.

If **Auto Lamp Control** is adjusted, **Manual Lamp Control** will automatically switch to **Off**.

- **Ambient Light: Ambient Light** detects ambient light intensity and automatically adjusts the screen brightness of all the LFDs in the same serial chain.

Tool Settings



1 Security

Panel Control

Turn on or off the screen of a display device.

Remote Control

Enable or disable the remote control.

2 Reset

Reset Picture

Reset the screen settings.

Reset Sound

Reset the sound settings.

Reset System

Reset the system settings.

Reset All

Reset the screen, sound and system settings at the same time.

3 Edit Column



Select the items you want to display in the list of sets.

4 Information

View the program information.

Other Functions

Resizing a Window

Place the mouse pointer on a corner of the program window. An arrow will appear. Move the arrow to customize the size of the program window.

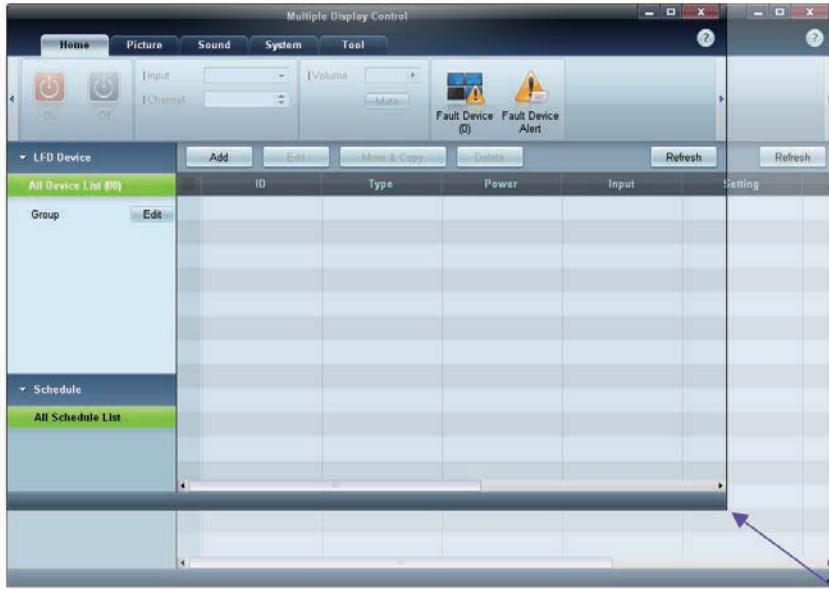

Group Management

Creating Groups

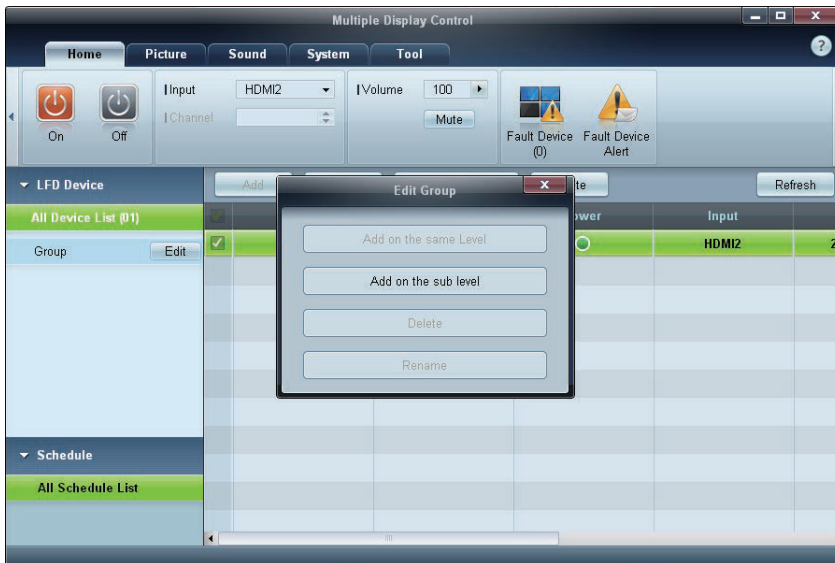

Create groups and manage the list of sets on a group basis.

 Duplicate group names cannot be used.

- 1 Right-click and select **Group>Edit** in the display device list section on the left side of the program window.
- 2 In the **Edit Group** window displayed, click **Add on the sub level** or **Add on the same level**.
 - **Add on the sub level:** Create a sub-group under the selected group.



- **Add on the same level:** Create a group on the same level as the selected group.





The **Add on the same level** button is enabled only if at least one group is created.

- 3 Enter the group name.

Deleting Groups

- 1 Select a group name, and click **Edit**.
- 2 In the **Edit Group** window displayed, click **Delete**.

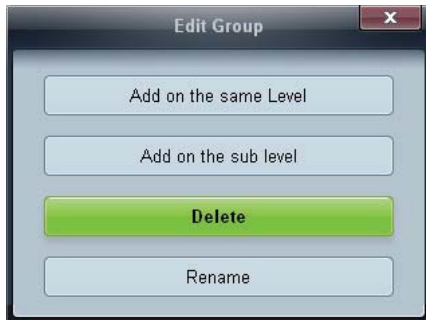

- 3 Click **Yes**. The group will be deleted.

Renaming Groups

- 1 Select a group name, and click **Edit**.
- 2 In the **Edit Group** window displayed, click **Rename**.



- 3 If a cursor appears in the old group name, enter a new group name.

Schedule Management

Creating Schedules

Create and register a schedule on a group basis.

- 1 Click **All Schedule List** in the schedule section on the left side of the program window. The **Add** button will be enabled in the middle.

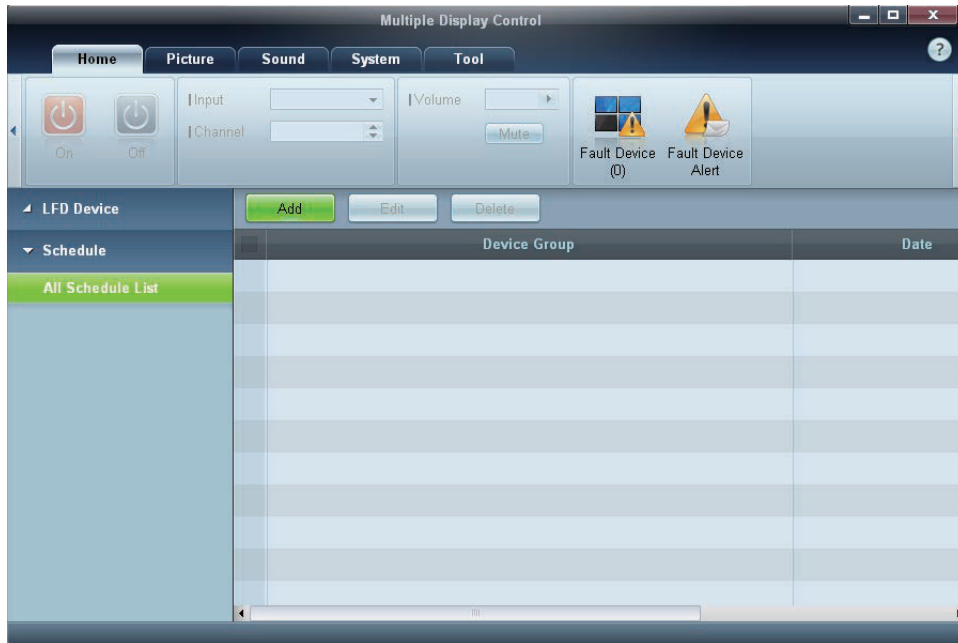

- 2 Click the **Add** button. The **Add Schedule** window will appear.

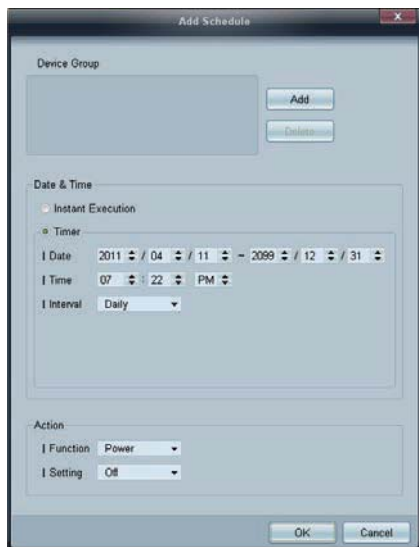

- 3 Click **Add** below the **Device Group** item, and select the group you want to add a schedule to.

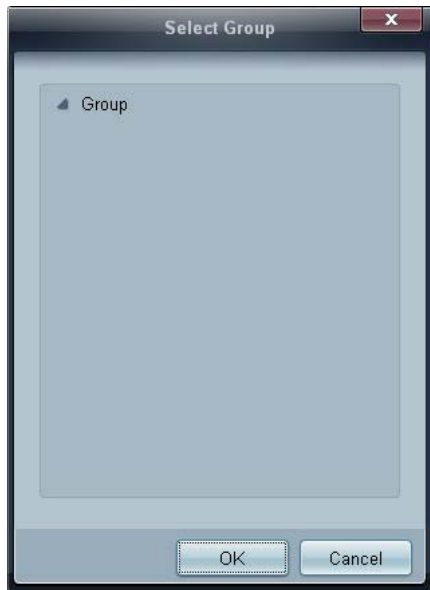

- 4 Select **Date&Time/Action** and click **OK**. The schedule will be added and a list of schedules will appear in the set list window.
- **Device Group:** Select a group.
 - **Date&Time**
 - **Instant Execution:** Run the schedule immediately.
 - **Timer** Set the date, time and interval to run the schedule.
 - **Action:** Select a function that will activate at the specified time and interval.



Schedule Modification

To modify a schedule, select the schedule and click **Edit**.

Deleting a Schedule

To delete a schedule, select the schedule and click **Delete**.

Troubleshooting Guide

Issue	Solution
<p>The display you want to control does not appear on the system information chart.</p>	<ol style="list-style-type: none"> 1. Check the connection of the RS232C cable (check that the cable is properly connected to appropriate serial port). 2. Check that another display with a duplicate ID is not connected. Connecting displays with a duplicate ID can cause the displays not to be shown due to data collision. 3. Check that the display ID is within the range of 0 and 99. (Change the ID using the Display menu.) <ul style="list-style-type: none">  For a display that supports the ID in a range of 0 to 99, the ID should be set between 0 and 99.
<p>The display you want to control does not appear on the other Control Info Grids.</p>	<p>Check that the display is powered on. (See the power status in the system information chart.)</p> <p>Ensure you select the input source the display is connected to.</p>
<p>The following message appears repeatedly.</p> 	<p>Check that the display you want to control is selected.</p>
<p>Displays power on or off at different time from one another even though On Time or Off Time is set.</p>	<p>Adjust the time on the PC to synchronize the time between the connected displays.</p>
<p>The remote control does not work.</p>	<p>The remote control may not work if the RS-232C cable is removed or the program is closed abnormally while the Remote Control function is Disable. To resolve this, run the program again and set Remote Control to Enable.</p>

 This program may malfunction sometimes due to a communication problem between the PC and display or electromagnetic waves emitted from nearby electronic devices.

How display properties are shown when multiple displays are used

- 1 When no display is selected: The default value is displayed.
- 2 When one display is selected: Settings for the selected display are displayed.
- 3 When two displays are selected (e.g. in sequence of **ID 1** and **ID 3**): The settings for **ID 1** are displayed before the settings for **ID 3**.
- 4 When the **All+Select** checkbox is checked and all displays are selected: The default settings are displayed.

Adjusting the LCD Display

Input

Available Modes

- **P** PC / DVI / DisplayPort
- **A** AV
- **C** Component
- **H** HDMI
- **M** MagicInfo
- **T** TV

Note

- **MagicInfo** can only be enabled when a network box(sold separately) is connected.
- A TV tuner box (sold separately) must be connected to use the TV. (US Only)

Source List **PACHMT**

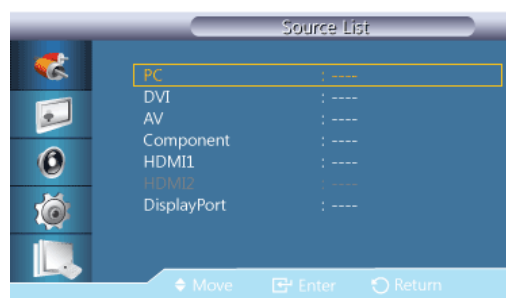

Use to select **PC**, HDMI or other external input sources connected to the LCD Display. Use to select the screen of your choice.

1. **PC**
2. **DVI**
3. **AV**
4. **Component**
5. **HDMI1**
6. **HDMI2**
7. **DisplayPort**
8. **MagicInfo** - Enabled if a network box is connected.
9. **TV**- Enabled if a TV tuner box is connected.

Note

The [RGB/COMPONENT IN] port is compatible with a PC or component input.

However, the picture may not display normally if you select an input source different from the actual connected input source.



PIP PAHT



The **PIP** function is not available when **Video Wall** is **On**.

When external AV devices such as VCRs or DVDs are connected to the LCD Display, **PIP** allows you to watch video from those devices in a small window super-imposed on the PC Video signal. (**Off/On**)



- PIP turns off when the LCD Display is switched to an external source.
- If you select , ,  in **Size**, **Position** and **Transparency** will not be activated.

PIP

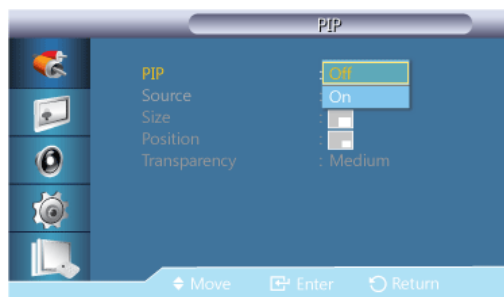

Turns the **PIP** Screen **Off/On**.

- **Off**
- **On**

Source

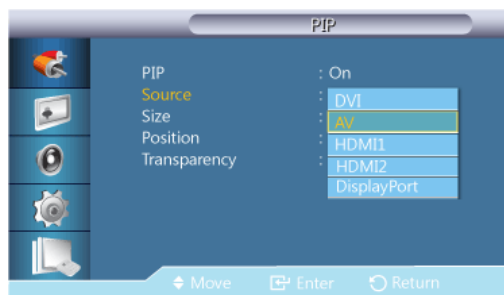

Selects the input source for the PIP.



- PIP is disabled if the primary screen does not receive a signal.
 - A TV tuner box (sold separately) must be connected to use the TV. (US Only)
 - **PC : DVI, AV, HDMI1, HDMI2, DisplayPort**
 - **DVI : PC**
-

- **AV : PC**
- **HDMI : PC**
- **DisplayPort : PC**

Size

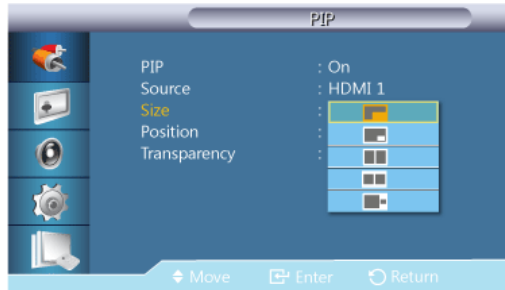

Changes the Size of the PIP window.

Position

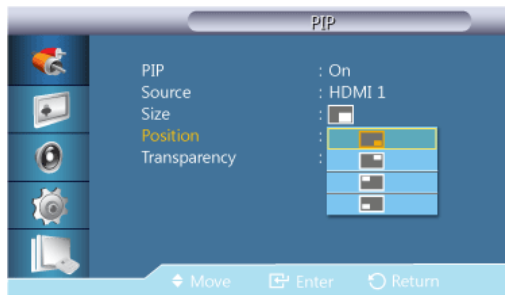

Changes the Position of the PIP window.

Transparency

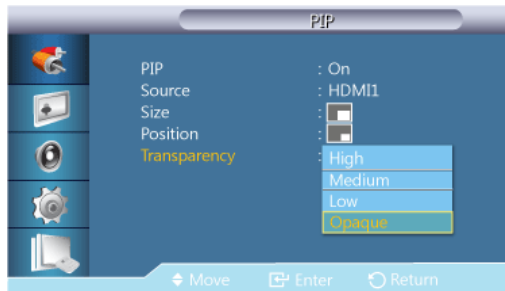

Adjusts the Transparency of PIP windows.

- **High**
 - **Medium**
 - **Low**
 - **Opaque**
-

Edit Name **PACHMT**

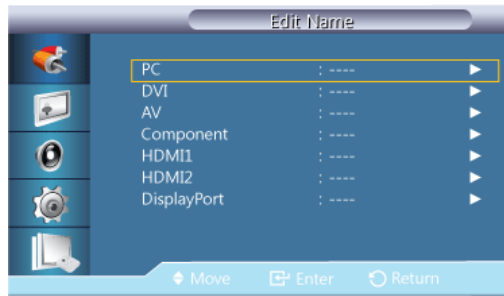

Name the input device connected to the input jacks to make your input source selection easier.

VCR / DVD / Cable STB / HD STB / Satellite STB / AV Receiver / DVD Receiver / Game / Camcorder / DVD Combo / DHR / PC / DVI PC / DVI Devices

Note

- The displayed devices differ depending on the external input mode.
- When connecting a PC to the HDMI terminal, set **Edit Name** to **PC**. In other cases, set **Edit Name** to **AV**. However, since 640 x 480, 720p (1280 x 720), and 1080p (1920 x 1080) are common signals for **AV** and **PC**, make sure to set the **Edit Name** in accordance with the input signal.
- When a PC is connected, set **Edit Name** to **DVI PC** to enjoy the video and audio from the connected PC.
- When an AV device is connected, set **Edit Name** to **DVI Device** to enjoy the video and audio from the connected AV device.

Source AutoSwitch Settings **PACHMT**

Turning on the display with **Source AutoSwitch On**, and the previous video source selection is not active, the display will automatically search the different video input sources for active video.

Note

- If the display TV source is active (TV tuner connected to the display) the **Source AutoSwitch** search function becomes inactive. The display will remain in the TV source.
- **Source AutoSwitch** selection and **PIP** function: If the **Source AutoSwitch** selection is set to **On**, the **PIP** function will not work, the **Source AutoSwitch** selection must be set to **Off**, for the **PIP** feature to work.
- When the **Source AutoSwitch** selection is **On**, and or the **Primary Source Recovery** is **On**, the display power saving mode becomes inactive.
- When **Primary Source Recovery** is **On**, only the **Primary Source** and **Secondary Source** selection are available and they are interchangeable and selectable at will.

Refer to **PIP > Source** for compatible signals for each primary input source.

Source AutoSwitch



When the **Source AutoSwitch** is **On**, the display video source will automatically be searched for active video.

The **Primary Source** selection will be activated, if the current video source is not recognized. **Secondary source** selection will become active, if no primary video source is available. If the primary or secondary source is not recognized, the display will search again, if no active video is found the display will show the no-input-signal message.

When the **Primary Source** selection is set to **All**, the display will search all the video source inputs twice in sequence looking for an active video source, returning back to the first video source in the sequence if no video is found.

1. **Off**
2. **On**

Primary Source Recovery

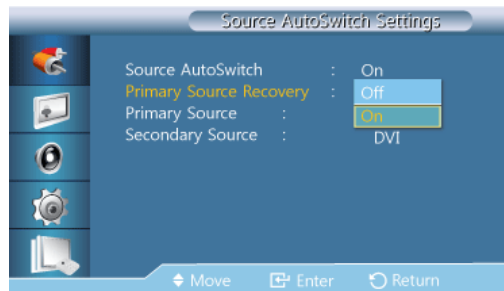

When **Primary Source Recovery** is **On**, only the **Primary Source** and **Secondary Source** video source selection will be searched for active video.

The **Primary Source** will be selected if active video is found, if no video is found, the **Secondary Source** will be selected, if no video is found in **Secondary Source** again, the no-input-signal is displayed.

1. **Off**
2. **On**

Primary Source

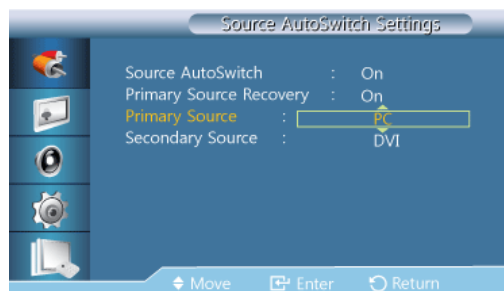

Specify **Primary Source** for the automatic input source.

Secondary Source

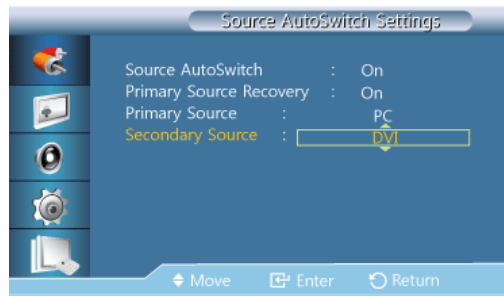

Specify **Secondary Source** for the automatic input source.

Picture [PC / DVI / DisplayPort / MagicInfo Mode]

- If connected to a PC, set Edit Name to **DVI PC**, and enjoy video or audio content saved on the PC.
- If connected to an AV device, set **Edit Name** to **DVI Device**, and enjoy video or audio content saved on the AV device.

Available Modes

- **P** PC / DVI / DisplayPort
- **A** AV
- **C** Component
- **H** HDMI
- **M** MagicInfo
- **T** TV

Note

- **MagicInfo** can only be enabled when a network box(sold separately) is connected.
- A TV tuner box (sold separately) must be connected to use the TV. (US Only)

Mode **PM**

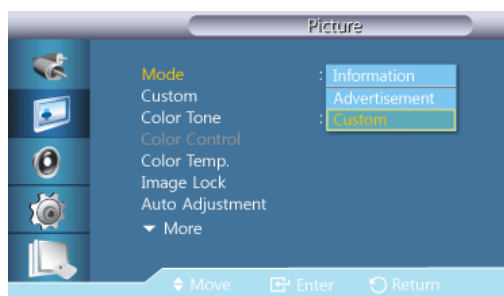

Note

Not available when **Dynamic Contrast** is set to **On**.

1. **Information**

Recommended for communicating exact information (e.g. public information).

2. **Advertisement**

Recommended for displaying advertisements (e.g. videos or indoor or outdoor ads).

3. **Custom**

Custom 

By using the on-screen menus, the contrast and brightness can be changed to your personal preference.



Note

- By adjusting the picture using the **Custom** function, **MagicBright** will change to **Custom** mode.
- Not available when **Dynamic Contrast** is set to **On**.

1. **Contrast**



Adjusts the Contrast.

2. **Brightness**



Adjusts the Brightness.

3. **Sharpness**



Adjusts the Sharpness.

4. **Gamma**



Adjust the mid-range brightness (Gamma) for the picture.

- **Natural**
 - **Mode 1** - Sets the picture brighter than **Natural**.
 - **Mode 2** - Sets the picture darker than **Mode1**.
-

- **Mode 3** - Increases the contrast between dark and bright colors.

Color Tone **PM**



Note

Not available when **Dynamic Contrast** is set to **On**.

The Color tones can be changed.

1. **Off**
2. **Cool**
3. **Normal**
4. **Warm**
5. **Custom**

Note

- If you set the **Color Tone** to **Cool**, **Normal**, **Warm**, or **Custom**, the **Color Temp.** function is disabled.
- If you set the **Color Tone** to **Off**, the **Color Control** function is disabled
- By adjusting the picture using the **Color Tone** function, **Mode** will change to **Custom** mode.

Color Control **PM**

Adjusts individual Red, Green, Blue Color balance.

Note

Not available when **Dynamic Contrast** is set to **On**.

1. **Red**



2. **Green**



3. **Blue**
-



Color Temp. **PM**



Color Temp. is a measure of the 'warmth' of the image Colors.

 **Note**

This function is enabled when **Mode** is set to **Custom**, and **Dynamic Contrast** and **Color Tone** are **Off**.

Image Lock **P**

Image Lock is used to fine-tune and get the best image by removing noise that creates unstable images with jitters and shakiness. If satisfactory results are not obtained using the Fine adjustment, use the Coarse adjustment and then use Fine again.

 **Note**

Available in **PC** mode only.

Coarse



Removes noise such as vertical stripes. Coarse adjustment may move the screen image area. You may relocate it to the Center using the horizontal control menu.

Fine



Removes noise such as horizontal stripes. If the noise persists even after Fine tuning, repeat it after adjusting the frequency (clock speed).

Position



Adjusts the screen location horizontally and vertically.

Auto Adjustment **P**

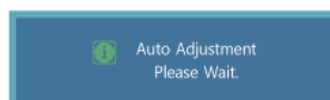

The values of **Fine**, **Coarse**, **Position** are adjusted automatically. By changing the resolution in the control panel, the auto function is performed.

 **Note**

Available in **PC** mode only.

Signal Balance^P

This is used to make up for the weak RGB signal transmitted by a long signal cable.

 **Note**

- Not available when **Dynamic Contrast** is set to **On**.
- Available in **PC** mode only.

Signal Balance

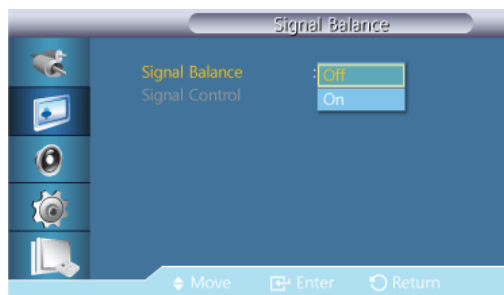

Selects either **On** or **Off** with the signal balance.

Signal Control

 **Note**

Available when **Signal Balance** is set to **On**.

1. R-Gain



2. G-Gain



3. B-Gain



4. R-Offset



5. G-Offset



6. B-Offset



Size **P**



The **Size** can be switched.

1. **16:9**
2. **4:3**

PIP Picture **P**

Adjusts the PIP Screen Settings.



Note

- Available Modes: **PIP On**

1. Contrast



Adjusts the Contrast of the PIP window on the screen.

2. Brightness



Adjusts the Brightness of the PIP window on the screen.

3. Sharpness



Adjusts the Sharpness of the PIP window on the screen.

4. Color



Adjusts the Color of the PIP window on the screen.



Note

Only enabled when the **PIP** input source is **HDMI**.

5. Tint



Adds a natural tone to the PIP window.



Note

The **Tint** slider is only displayed when **PIP** input source is **HDMI** or **AV**.

Dynamic Contrast **PM**



Dynamic Contrast automatically detects the distribution of the visual signal and adjusts to create an optimum contrast.

1. **Off**
2. **On**



Note

This function is disabled when **PIP** or **Energy Saving** is **On**.

Lamp Control **PM**



Adjusts the inverter lamp in order to reduce energy consumption.



Note

Not available when **Dynamic Contrast** is set to **On**.

Picture Reset **PM**

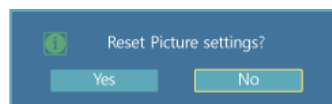

Reset the screen settings.

Picture [AV / HDMI / TV / Component Mode]

Available Modes

- **P** PC / DVI / DisplayPort
 - **A** AV
 - **C** Component
-

- **H** HDMI
- **M** MagicInfo
- **T** TV

 **Note**

- **MagicInfo** can only be enabled when a network box(sold separately) is connected.
- A TV tuner box (sold separately) must be connected to use the TV. (US Only)

Mode **A** **H** **C** **T**



The LCD Display has four automatic picture settings ("**Dynamic**", "**Standard**", "**Movie**" and "**Custom**") that are preset at the factory.

 **Note**

Not available when **Dynamic Contrast** is set to **On**.

1. **Dynamic**
2. **Standard**
3. **Movie**
4. **Custom**

Custom **A** **H** **C** **T**

By using the on-screen menus, the contrast and brightness can be changed to your personal preference.

 **Note**

Not available when **Dynamic Contrast** is set to **On**.

Contrast



Adjusts the Contrast.

Brightness



Adjusts the Brightness.

Sharpness



Adjusts the picture Sharpness.

Color



Adjusts the picture Color.

Tint



Adds a natural tone to the display.



Note

The tint slider is only displayed when input source is **HDMI** or **AV**.

Color Tone **AHCT**



The Color tones can be changed. The individual Color components are also user adjustable.



Note

Not available when **Dynamic Contrast** is set to **On**.

1. **Off**
2. **Cool2**
3. **Cool1**
4. **Normal**
5. **Warm1**
6. **Warm2**



Note

- If you set the **Color Tone** to **Cool2**, **Cool1**, **Normal**, **Warm1**, or **Warm2**, the **Color Temp.** function is disabled.
- By adjusting the picture using the **Color Tone** function, **Mode** will change to **Custom** mode.

Color Temp. **AHCT**



Color Temp. is a measure of the 'warmth' of the image Colors.



Note

This function is enabled when **Mode** is set to **Custom**, and **Dynamic Contrast** and **Color Tone** are **Off**.

Size **AHC**



The **Size** can be switched.

PC mode(PC, HDMI[PC Timing]): **16:9 - 4:3**

Video mode (**HDMI** [Video Timing], **AV** or **Component**): **16:9 - Zoom1 - Zoom2 - 4:3 - Screen Fit - Custom**

1. **16:9** - Sets the picture to 16:9 wide mode.
2. **Zoom 1** - Magnifies the size of the picture on the screen.
3. **Zoom 2** - Magnifies the size of the picture more than **Zoom 1**.
4. **4:3** - Sets the picture to 4:3 normal mode.
5. **Screen Fit** - Displays the input scenes as they are without any cutoff when HDMI 720p, 1080i, 1080p signals are input.
6. **Custom** - Changes the resolution to suit the user's preferences.



Note

- Certain external devices may feed the display an out of spec signal that may cause cutoff even when using the **Screen Fit** feature.
 - **Screen Fit** is enabled for only 1080i/p in **Component** mode and for 1080i/p or 720p in **HDMI** mode.
 - **Zoom 1** and **Zoom 2** are disabled for HD signals (1080i/p, 720p or 768p).
 - The **Position** and **Reset** functions are available in **Zoom 1** or **Zoom 2** modes.
-

Digital NR (Digital Noise Reduction) **AHC**



Turns the Digital Noise Reduction feature **Off/On**. The Digital Noise Reduction feature allows you to enjoy clearer and crisper images.

1. **Off**
2. **On**



Digital NR function is not available for all resolutions.

HDMI Black Level **H**



When a DVD or set-top box is connected to your TV via HDMI, it may cause a degradation in the screen quality, such as an increase in the black level, a low contrast, or discoloration, etc., depending on the external device connected. In this case, adjust the screen quality of your TV by configuring the **HDMI Black Level**.

1. **Normal**
2. **Low**



For Timing which can be used for both the PC and the DTV in **HDMI** mode, **HDMI Black Level** will be activated.

Film Mode **ACH**

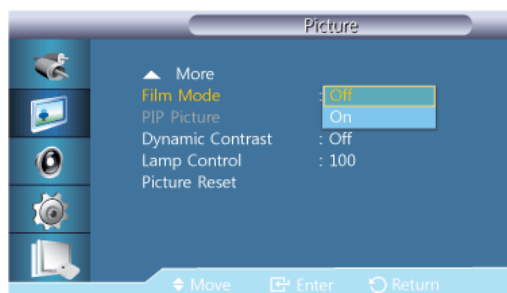

Film Mode calibrates unnatural pictures that may occur in a movie (which is in 24 frames).

Moving subtitles may appear corrupted when this mode is enabled.

(In **HDMI** mode, this function is available when the input signal is interlaced scan; it is not available in progressive scan.)

1. **Off**
2. **On**

PIP Picture **AHCG**

Adjusts the **PIP** Screen Settings.



Available Modes: **PIP On**

1. **Contrast**



Adjusts the Contrast of the PIP window on the screen.

2. **Brightness**



Adjusts the Brightness of the PIP window on the screen.

3. **Sharpness**



Adjusts the Sharpness of the PIP window on the screen.

Dynamic Contrast **AHCT**

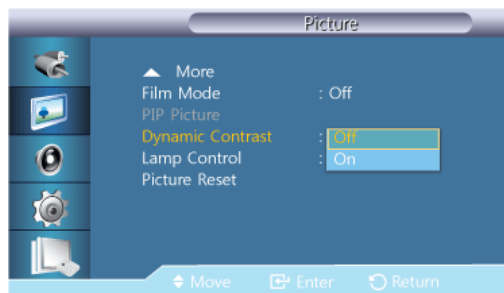

Dynamic Contrast automatically detects the distribution of the visual signal and adjusts to create an optimum contrast.

1. **Off**
2. **On**



This function is disabled when **PIP** or **Energy Saving** is **On**.

Lamp Control **AHCT**



Adjusts the inverter lamp in order to reduce energy consumption.



Note

Not available when **Dynamic Contrast** is set to **On**.

Picture Reset **AHCT**

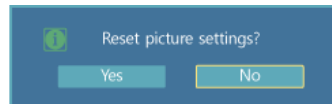

Reset the screen settings.

Sound

Available Modes

- **P** PC / DVI / DisplayPort
- **A** AV
- **C** Component
- **H** HDMI
- **M** MagicInfo
- **T** TV



Note

- **MagicInfo** can only be enabled when a network box(sold separately) is connected.
- A TV tuner box (sold separately) must be connected to use the TV. (US Only)

Mode **PACHMT**



The LCD Display has a built-in high fidelity stereo amplifier.

1. Standard

Selects **Standard** for the standard factory settings.

2. Music

Selects **Music** when watching music videos or concerts.

3. **Movie**

Selects **Movie** when viewing movies.

4. **Speech**

Selects **Speech** when watching a show that is mostly dialog (i.e., news).

5. **Custom**

Selects **Custom** if you want to adjust the settings according to your personal preferences.

Custom **PACHMT**

The sound settings can be adjusted to suit your personal preferences.

 **Note**

- You can hear the sound even when sound value is set to 0.
- If you adjust sound using **Custom** function, **Mode** will turn to **Custom** mode.

Bass



Emphasizes low frequency audio.

Treble



Emphasizes high frequency audio.

Balance



Allows you to Adjusts the sound balance between the left and right speakers.

Auto Volume **PACHMT**



Reduces the difference in volume control between broadcasters.

1. **Off**

2. **On**

SRS TS XT **PACHMT**



SRS TS XT is a patented SRS technology that solves the problem of playing 5.1 multichannel content over two speakers. TruSurround XT delivers a compelling, virtual surround sound experience through any two-speaker playback system, including internal television speakers. It is fully compatible with all multichannel formats.

1. **Off**
2. **On**

Sound Select **PAHT**

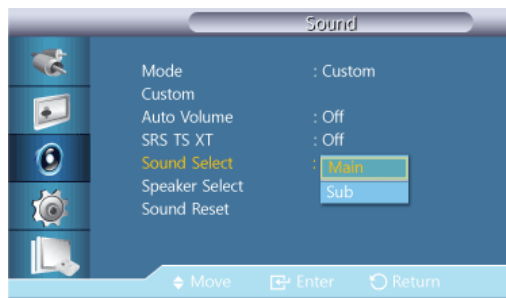

Enable the sound of either the primary or secondary display in **PIP** mode.

Note

Available when **PIP** is set to **On**.

1. **Main**
2. **Sub**

Speaker Select **PACHMT**

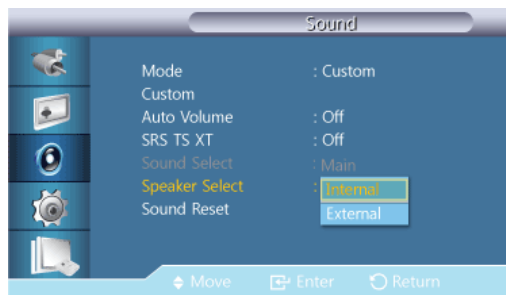

When you use the product with it connecting to a Home Theater, turn the internal speakers off so you can listen to sound from the Home Theater's (external) speakers.

1. **Internal**

Sound is outputted both from the **Internal** speaker and the **External** speakers, but the volume control is only available from the **Internal** speaker.

2. External

When sound is only outputted from the **External** speakers, the volume control is also only available from the **External** speakers.

Sound Reset **PACHMT**

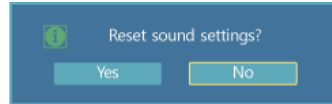

Reset the sound settings.

Setup

Available Modes

- **P** PC / DVI / DisplayPort
- **A** AV
- **C** Component
- **H** HDMI
- **M** MagicInfo
- **T** TV



Note

- **MagicInfo** can only be enabled when a network box(sold separately) is connected.
- A TV tuner box (sold separately) must be connected to use the TV. (US Only)

Language **PACHMT**

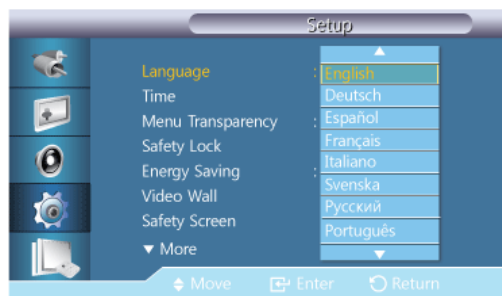

You can choose one of 13 languages.

English, Deutsch, Español, Français, Italiano, Svenska, Русский
Português, Türkçe, 简体中文, 繁體中文, 日本語, 한국어



Note

The language chosen affects only the language of the OSD. It has no effect on any software running on the computer.

TimePACHMT

Selects from one of 4 time settings, **Clock Set**, **Sleep Timer**, **Timer**, and **Holiday Management**.

Clock Set

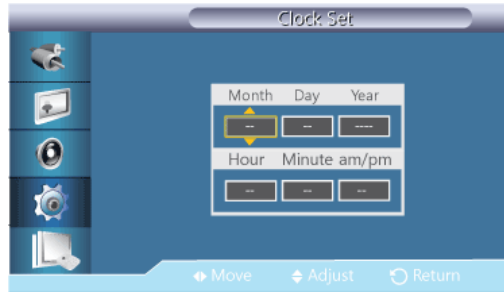

Current Time Setting.

Sleep Timer



Turns the LCD Display off automatically at certain times.

1. **Off**
2. **30**
3. **60**
4. **90**
5. **120**
6. **150**
7. **180**

Timer1 / Timer2 / Timer3

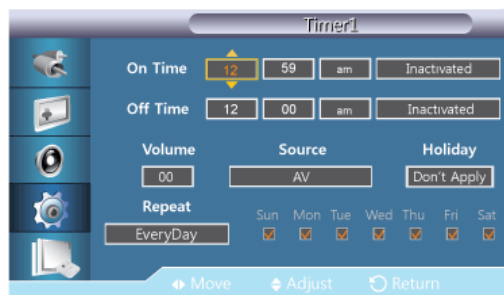

You can set the LCD display to automatically turn on or off at a specified time.

 **Note**

- Only enabled when the clock is set using the **Clock Set** menu.
- The **Manual** option allows you to select a day of the week.
- **Holiday** : When choose **Apply**, timer is not available on holiday; when choose **Don't apply**, timer is available on holiday.

Holiday Management

- **Add**

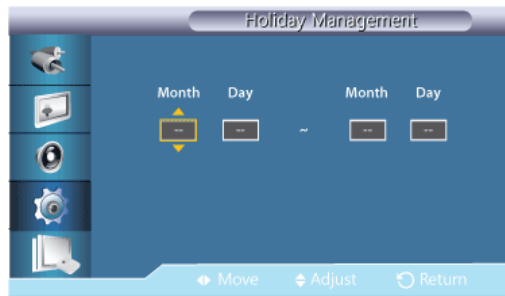

You can register holidays.

- **Delete Selected**

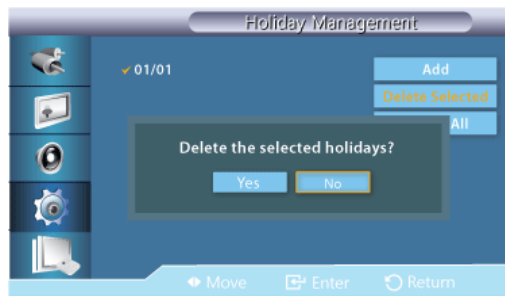

You can delete selected holidays.

 **Note**

- Only enabled when registered holidays are selected.
- More than one holiday can be selected and deleted.

- **Delete All**

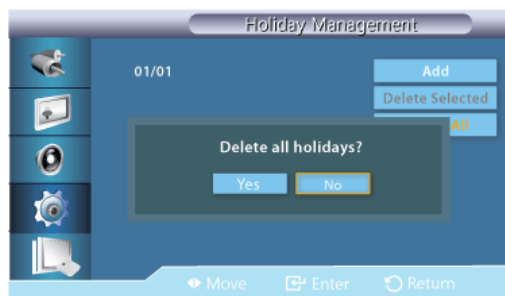

You can delete all the registered holidays.

Menu Transparency **PACHMT**



Change the transparency of the background of the OSD.

1. **High**
2. **Medium**
3. **Low**
4. **Opaque**

Safety Lock **PACHMT**

Change PIN



The password can be changed.

The preset password for the LCD Display is "0000".

 **Note**

If you forgot your password, press the remote buttons INFO + EXIT + MUTE to reset the password to "0000."

Lock

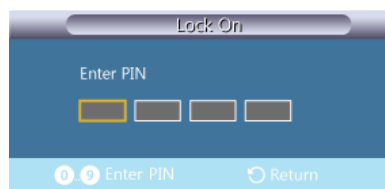

This is the function that locks the OSD in order to keep the current settings or to prevent others from adjusting the settings.

Energy Saving PACHMT



This feature adjusts the power consumption of the unit in order to save energy.

1. **Off**
2. **On**

Video Wall PACHMT

A **Video Wall** is a set of video screens connected together, so that each screen shows a part of the whole picture or where the same picture is repeated on each screen.

When the **Video Wall** is on, you can adjust the **Video Wall** screen setting.

Note

- When **Video Wall** is running, the **Size** functions are not available.
- Disabled when **PIP** is set to **On**.
- When a **Horizontal** or **Vertical** split is greater than four, use a resolution of XGA 1024 x 768 or greater to prevent any picture degradation.

Video Wall



Turns Off/On the **Video Wall** function of the selected display Off/On.

- **Off**
- **On**

Format



The **Format** can be selected to see a divided screen.

- **Full**

Provides a full screen without any margins.

- **Natural**

Displays a natural image with the original aspect ratio intact.

Horizontal



Sets how many parts the screen should be divided horizontally.

Fifteen adjustment levels: 1~15.



Note

If **Vertical** is set to **15**, the maximum value for **Horizontal** is **6**.

Vertical



Sets how many parts the screen should be divided vertically.

Fifteen adjustment levels: 1~15.



Note

If **Horizontal** is set to **15**, the maximum value for **Vertical** is **6**.

Screen Position



The screen can be divided into several images. A number of screens can be selected with a different layout when dividing.

- Select a mode in **Screen Position**.
- Select a display in Display Selection.
- The selection will be set up by pressing a number in the selected mode.
- The screen can be split into a maximum of 100 sub-screens.

 **Note**

When more than four displays are connected, we recommend a resolution of XGA (1024 x 768) or greater to prevent any picture degradation.

Safety Screen **PACHMT**

The **Safety Screen** function is used to prevent afterimages that may appear when a still picture is displayed on the screen over a long time.

 **Note**

This function is not available when the power is turned off.

Pixel Shift

Pixel Shift

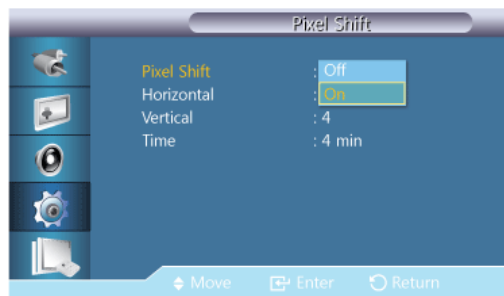

To prevent after-images on the screen, you can use this function to have pixels move on the LCD in the horizontal or vertical direction.

- **Off**
- **On**

Horizontal

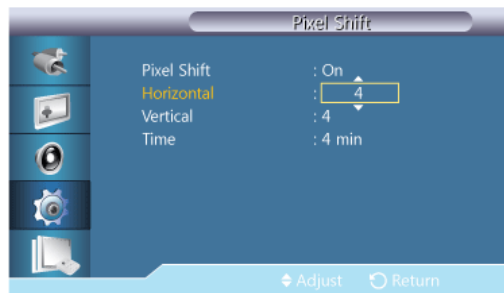

Sets how many pixels the screen moves horizontally.

Five adjustment levels: 0, 1, 2, 3, and 4.

Vertical

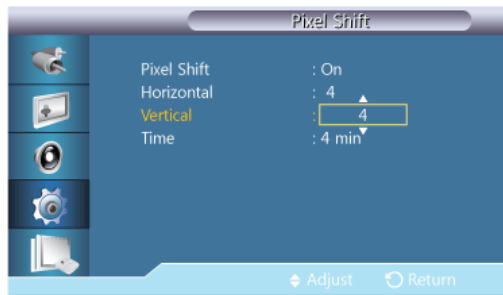

Sets how many pixels the screen moves vertically.

Five adjustment levels: 0, 1, 2, 3, and 4.

Time

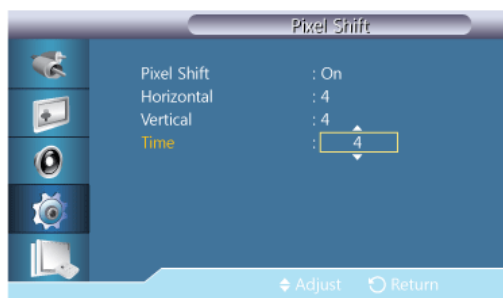

Set the time interval for performing the horizontal or vertical movement, respectively.

Timer

Timer

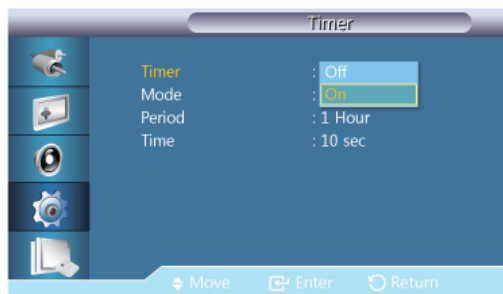

You can set the timer for Screen Burn Protection.

If you start the operation to erase any residual image, the operation will be performed for the set period of time and then automatically finish.

- **Off**
- **On**

Mode

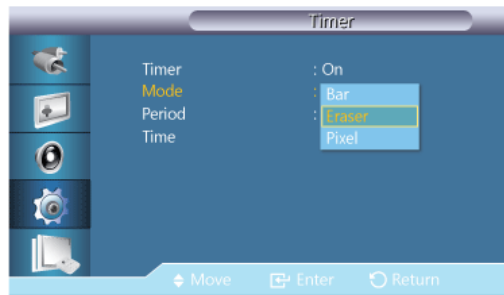

You can change the **Safety Screen Type**.

- **Bar**
- **Eraser**
- **Pixel**

Period



Use this function to set the execution period for each mode set in the timer.

Time

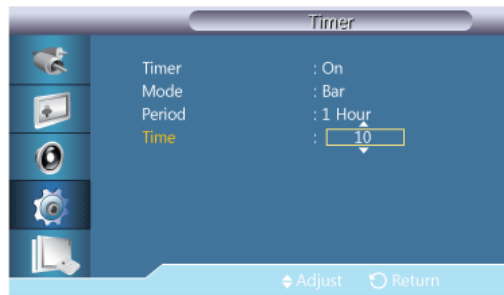

Within the set period of time specify a time for execution.

Bar



This function prevents after-images on the screen by moving long black and white vertical lines.

Eraser



This function prevents after-images on the screen by moving a rectangular pattern.

Pixel

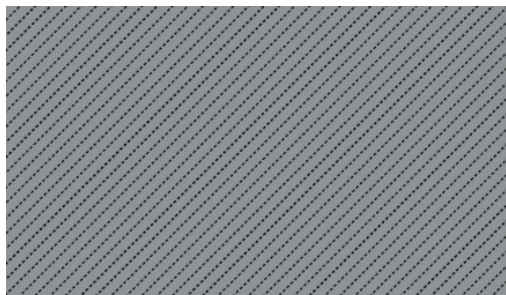

This function prevents after-images by moving many pixels on the screen.

Side Gray



Select the brightness of the grey for the screen background.

- **OFF**
- **Light**
- **Dark**

Resolution Select **P**

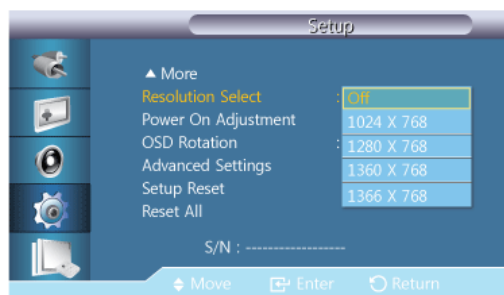

When the picture is not displayed properly on the screen when setting the graphics card resolution of the computer to **1024 x 768 @ 60Hz**, **1280 x 768 @ 60Hz**, **1360 x 768@**

60Hz or 1366 x 768 @ 60Hz, by using this function(Resolution Select), you can have the picture displayed on the screen in the specified resolution.

 **Note**

Available in **PC** mode only.

1. **Off**
2. **1024 x 768**
3. **1280 x 768**
4. **1360 x 768**
5. **1366 x 768**

 **Note**

Selecting the menu is only allowed when the graphics resolution is set to **1024 x 768 @ 60Hz, 1280 x 768 @ 60Hz, 1360 x 768 @ 60Hz or 1366 x 768 @ 60Hz**.

Power On Adjustment **PACHMT**

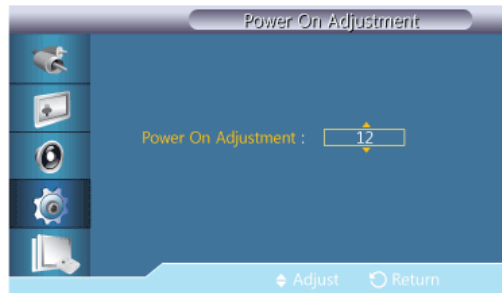

Adjusts the Power On time for the screen.



Caution: Set the Power On time to be longer to avoid overvoltage.

OSD Rotation **PACHMT**



OSD Rotate

1. **Landscape**
2. **Portrait**

Advanced Settings **PACHMT**

Configures the settings more elaborately.

Fan & Temperature

Protects the product by detecting the fan speed and internal temperature.

Fan Control

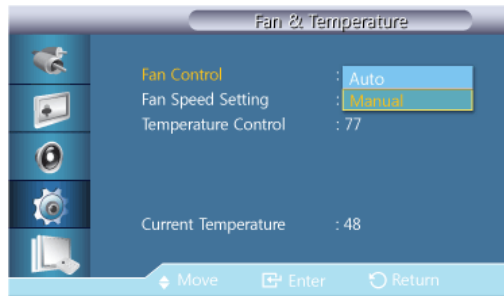

Selects auto or manual for the fan speed settings.

- **Auto**
- **Manual**

Fan Speed Setting

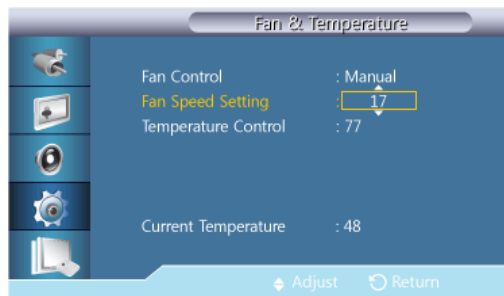

Sets the fan speed within a range of **0** and **100**.

 **Note**

Enabled when **Fan Control** is set to **Manual**.

Temperature Control

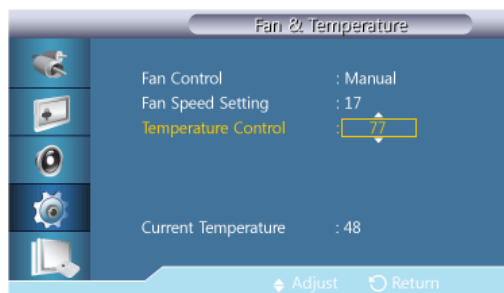

Detects the product's internal temperature and specifies the desired temperature.

The product is set to 77°C by default.

 **Note**

- The picture will be dimmed if the temperature exceeds the specified temperature, and the product will automatically power off to prevent overheating if the temperature keeps rising.
-

- It is best to use the product at temperatures 75 - 80°C (based on ambient temperature of 40°C). Refer to "Specifications" herein for details about operating conditions.

 **Note**

It is best to set **Fan Control** to **Auto** when you change the **Temperature Control** setting.

Current Temperature

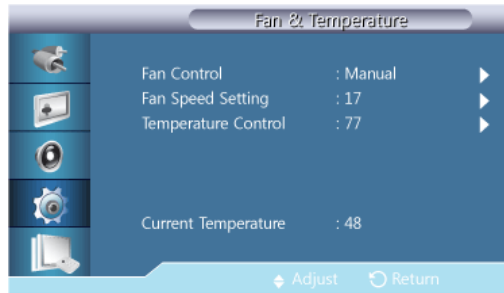

Shows the current temperature of the product.

Auto Power



Enables or disables **Auto Power** for the product.

- **Off**
- **On**

 **Note**

When **Auto Power** is **On**, the product will power on automatically as soon as it is connected to power.

Button Lock



Locks or unlocks the monitor control buttons on the product.

- **Off**
-

- **On**

User Auto Color

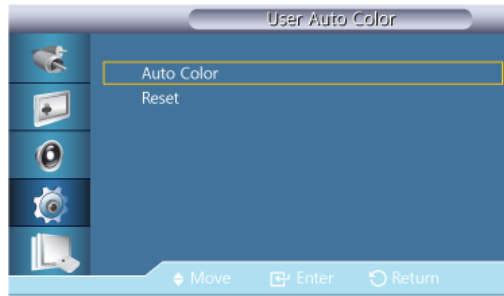

1. **Auto Color**

Automatically adjusts the Colors.

2. **Reset**

Resets the Color settings.



Note

Enabled only in **PC** mode.

Standby Control



Sets the standby mode, which will be activated when no input signal is detected.

- **Off**

A message will read **<No Signal>** if no input signal is detected.

- **On**

Power-saving mode will be activated if no input signal is detected.

- **Auto**

When no input signal is detected,

- Power-saving mode will be activated if an external device is connected.

- A message will read **<No Signal>** if no external device is connected.



Note

- Enabled only in **PC, DVI, HDMI, or DP(DisplayPort)** mode.
 - **Auto** will be disabled in **HDMI** mode.
-

Lamp Schedule

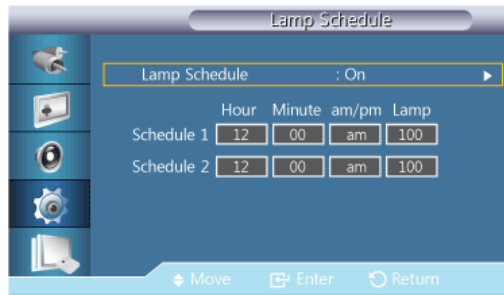

Adjusts the luminance to a user-specified value at a specified time.

OSD Display

Displays or hides a menu item on the screen.

Source OSD

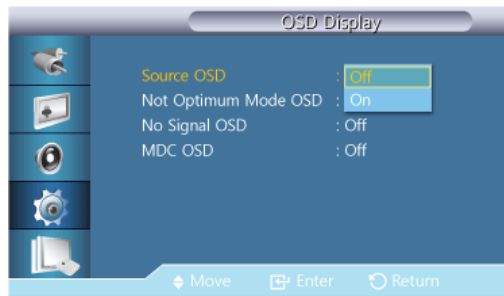

- Off
- On

Not Optimum Mode OSD

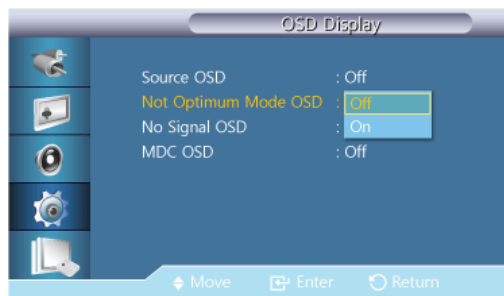

- Off
- On

No Signal OSD



- Off
 - On
-

- Off
- On

MDC OSD

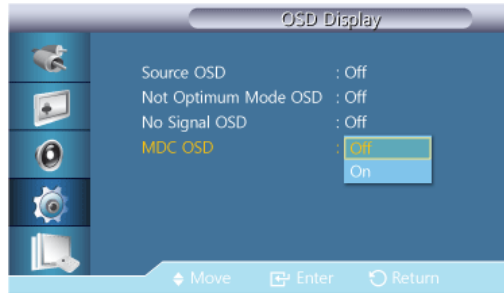

- Off
- On

Software Upgrade

Performs a software upgrade.

1. Connect the product to a computer via a digital signal such as **DVI** or **HDMI**. Click the BMP image file converted from an SW code. The image below will appear on the screen of the product.
2. While a BMP image onto which the software code has been converted is displayed on the screen, select **Software Upgrade**.



Note

When there are two or more BMP images, they are displayed on the screen using a slideshow.

- It is recommended that the playback interval between two BMP images in the slideshow should be one second. The image extraction probability will decrease with other playback intervals.
 - A BMP image might not be extracted if it is covered by another image (for example, the mouse pointer).
3. If a more recent version than the current software version is detected, you will be asked whether to upgrade the current software. If you select **<Yes>**, the upgrade is performed.
 4. When the software upgrade is completed, the product is turned off and on automatically.

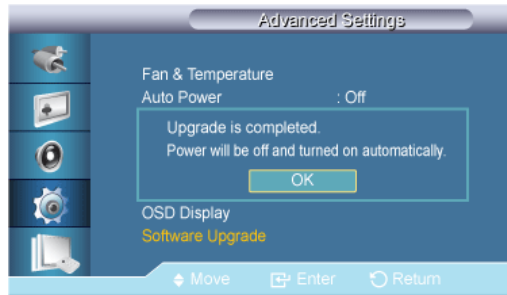

Note

- This only operates with a digital signal, such as in **DVI**, **HDMI1**, or **HDMI2** mode. (The input resolution must be identical to the panel resolution.)
- In **HDMI1** and **HDMI2** modes, the timing values used for both the PC and TV are only supported if the **Edit Name** is set to **PC** or **DVI PC**.
- This is only supported if the **Size** is set to **16:9**.

Setup Reset **PACHMT**

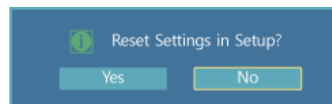

Reset all the values for a setting.

Reset All **PACHMT**

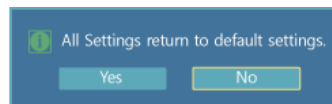

Reset all the settings for the display.

Multi Control

Available Modes

- **P** PC / DVI / DisplayPort
- **A** AV
- **C** Component
- **H** HDMI
- **M** MagicInfo
- **T** TV

Note

- **MagicInfo** can only be enabled when a network box(sold separately) is connected.
 - A TV tuner box (sold separately) must be connected to use the TV. (US Only)
-

Multi Control **PACHMT**

Assigns an individual ID to the SET.

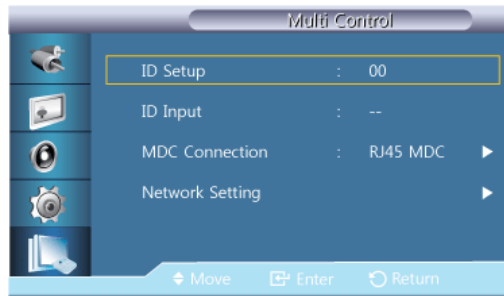

- **ID Setup**

Assigns distinctive IDs to the SET.

- **ID Input**

Use to select the transmitter functions of the individual SET. Only a SET where the ID corresponds to the transmitter setting becomes activated.

- **MDC Connection**

Selects a port to receive the MDC inputs from.

- **RS232C MDC** : Communicates with the MDC via a **RS232C MDC** cable.
- **RJ45 MDC** : Communicates with the MDC via an **RJ45 MDC** cable.

- **Network Setting**

- **IP Setting** : **Manual, Auto**
- **IP Address** : Manually enter the **IP Address** if **IP Setting** is set to **Manual**.
- **Subnet Mask** : Manually enter the **Subnet Mask** if **IP Setting** is set to **Manual**.
- **Gateway** : Manually enter the **Gateway** if **IP Setting** is set to **Manual**.

MagicInfo

Available Modes

- **P** PC / DVI / DisplayPort
- **A** AV
- **C** Component
- **H** HDMI
- **M** MagicInfo
- **T** TV

 **Note**

- **MagicInfo** can only be enabled when a network box(sold separately) is connected.
-

- A TV tuner box (sold separately) must be connected to use the TV. (US Only)



Note

- The remote control can be used to select **MagicInfo**. However, it is recommended to use a separate USB keyboard to utilize **MagicInfo** fully.
- For **MagicInfo** in Device mode, moving external devices while booting may cause errors. Set up external devices only if the LCD Display turns on.
- Do not unplug the LAN cable used for the network (ex: video display). Otherwise, the Program (MagicInfo) may stop. If you do unplug the cable, restart the system.
- Do not unplug the LAN cable used by an USB device (ex: video display). Otherwise, the Program (MagicInfo) may stop.

- To access other sources, press the SOURCE button in **MagicInfo**.

- The preset password for the LCD Display is "000000".

- The server Program's Power-On option works only if the LCD Display's power is completely shut off.

Please make sure not to use the Power-On option when the LCD Display is in the process of shutting down since this may cause system errors on the LCD Display.

- When using **MagicInfo** with the MagicInfo Server Program: perform Network mode.
- When using **MagicInfo** with the device directly connected to LCD Display : execute Device mode.

- Press ESC to directly go to the **MagicInfo** Window screen.

- To setup **MagicInfo** on a Windows screen, a keyboard and mouse are required.

- To setup **MagicInfo** on a Windows screen, refer to the MagicInfo Server Help.

It is highly recommended not to turn off the AC power during an operation.

- For pivoted LCD Displays, ticker transparency is not supported.
- For pivoted LCD Displays, a screen resolution of up to 720 x 480(SD) is supported for movies.

- For drive D:, **EFW** is not applied.

- To save Setup contents that have been changed when **EFW** is in the **Enable** state, you must **Commit** them.

- By selecting **Disable**, **Enable** or **Commit**, the system is restarted.

MagicInfo

1. Select Application - step 1
-

Adjusting the LCD Display

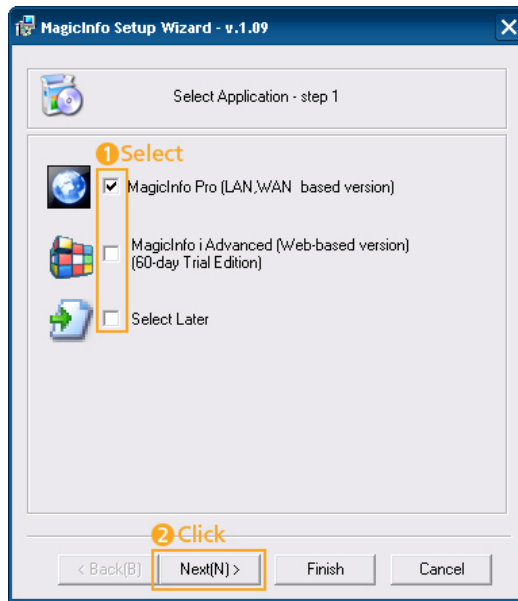

You can select an Application to be executed in your computer when Windows starts.

2. Select TCP/IP - step 2

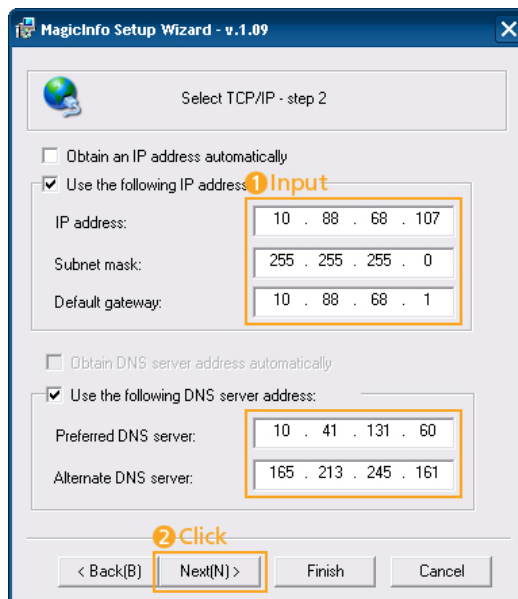

In step 2 of MagicInfo Setup Wizard, you don't have to go to Network Setting on the desktop to make your settings for TCP/IP. You just do that at step 2 of MagicInfo installation.

3. Select Language - step 3

Adjusting the LCD Display

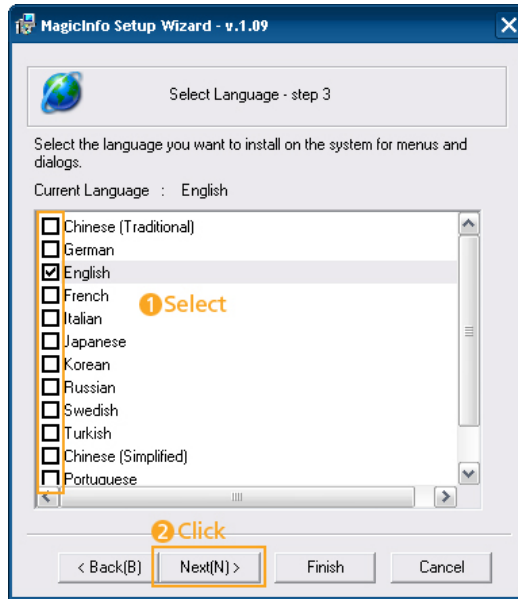

When using multiple languages, you can choose and set a specific language among them.

4. Select Screen Type - step 4

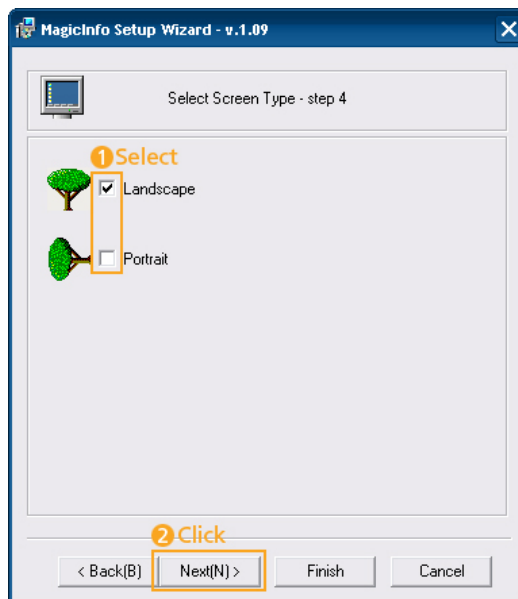

You can select which rotation type will be applied to your device.

5. Setup Information

Adjusting the LCD Display

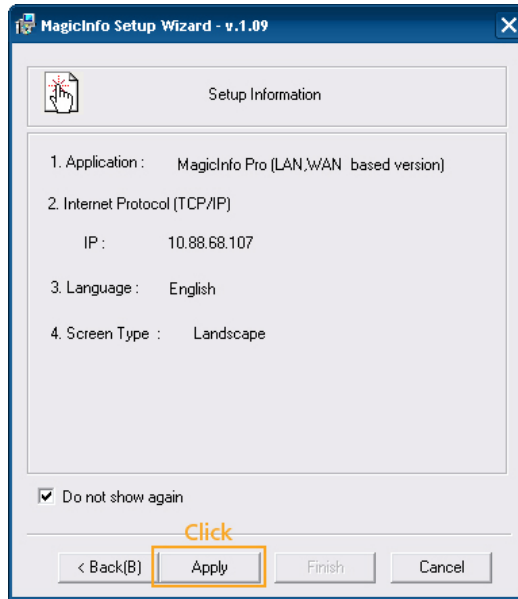

Shows the settings that have been selected by the user.

Note

If the **MagicInfo** icon is not displayed on the notification area, double click the **MagicInfo** icon on the window desktop. The icon will appear.

Troubleshooting

Self-Test Feature Check



Check the following items yourself before calling for assistance. Contact a Service Center for problems that you cannot solve by yourself.

Self-Test Feature Check

1. Turn off both your computer and the LCD Display.
2. Unplug the video cable from the back of the computer.
3. Turn on the LCD Display.

The figure shown below ("**No Signal**") appears on a black background when the LCD Display is working normally even though no video signal is detected: While in the Self-Test mode, the LED power indicator remains green and the figure moves around on the screen.



4. Turn off your LCD Display and reconnect the video cable; then turn on both your computer and the LCD Display

If your LCD Display screen remains blank after using the previous procedure, check your video controller and computer system; your LCD Display is functioning properly.

Warning Messages

You can even view the screen at a resolution of 1920 x 1080. However, you will receive the following message for a minute; You can choose to change the screen resolution or stay in the current mode during that time. If the resolution is more than 85Hz, you will see the black screen because the LCD Display does not support over 85Hz.

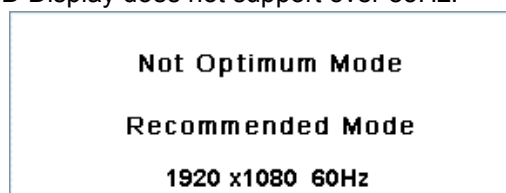

Refer to Specifications > Preset Timing Modes for the resolutions or frequencies supported by the LCD Display.

Maintenance and Cleaning

- 1) Maintaining the LCD Display Case.

Clean with a soft cloth after disconnecting the power cord.



- Do not use benzene, thinner or other flammable substances.

2) Maintaining the Flat Panel Display Screen.

Clean with a soft cloth (cotton flannel).



- Never use acetone, benzene or thinner.
(They may cause flaws or deformation of the screen surface.)
- The user is responsible for any damage caused by using these substances.

Symptoms and recommended Actions



Note

A LCD Display recreates visual signals received from the computer. Therefore, if there is a problem with the computer or the video card, this can cause the LCD Display to become blank, have poor Coloring, become noisy, etc. In this case, first check the source of the problem, and then contact a Service Center or your dealer.

1. Check if the power cord and the video cables are properly connected to the computer.
2. Check if the computer beeps more than 3 times when booting.
(If it does, request service.)
3. If you installed a new video card or if you assembled the PC, check if you installed the Adaptor(video).
4. Check if the scanning ratio of the video screen is set to between 50 Hz ~ 85 Hz.
(Do not exceed 60Hz when using the maximum resolution.)
5. If you have problems in installing the Adaptor (video) driver, boot the computer in Safe Mode, remove the Display Adaptor in the "Control Panel -> System -> Device Administrator" and then reboot the computer to reinstall the Adaptor (video) driver.

Check List



Note

- The following table lists possible problems and their solutions. Before calling for assistance, check the information in this section to see if you can remedy any problems for yourself. If you do need assistance, please call the phone number on the Information section or contact your dealer.
- For more network-related information, refer to the MagicInfo Troubleshooting section.

Problems related to the Installation



Note

Problems related to the LCD Display installation and their solutions are listed.

Q: The LCD Display screen flickers.

A: Check if the signal cable between the computer and the LCD Display is securely connected.

(Refer to Connecting a Computer)

Problems related to the Screen



Note

Problems related to the LCD Display screen and their solutions are listed.

Q: The screen is blank and the power indicator is off.

A: Ensure that the power cord is firmly connected and the LCD Display is on.

(Refer to the Connecting a Computer)

Q: **"No signal"** message.

A: Ensure that the signal cable is firmly connected to the PC or video sources.

(Refer to the Connecting a Computer)

A: Ensure that the PC or video sources are turned on.

Q: **"Not Optimum Mode"** message.

A: Check the maximum resolution and the frequency of the video Adaptor.

A: Compare these values with the data in the Preset Timing Modes Chart.

Q: The picture rolls vertically.

A: Check if the signal cable is securely connected. Re-connect it, if necessary.

(Refer to Connecting a Computer)

Q: The image is not clear; picture is blurred.

A: Run Frequency **Coarse** and **Fine** tuning.

A: Turn on again after removing all accessories (video extension cable, etc.)

A: Set the resolution and frequency to the recommended ranges.

Q: The picture image is unstable and shakes.

A: Check if the resolution and frequency set for the computer video card falls in the range supported by the LCD Display. If not, reset them referring to the current Information under the LCD Display menu and Preset Timing Modes.

Q: Ghost images are shown in the picture.

A: Check if the resolution and frequency set for the computer video card falls in the range supported by the LCD Display. If not, reset them referring to the current Information under the LCD Display menu and Preset Timing Modes.

Q: The image is too light or too dark.

A: Adjust the **Brightness** and **Contrast**.

(Refer to the **Brightness, Contrast**)

- Q: The screen Color is inconsistent.
- A: Adjust the **Color Control** option in the OSD adjustment menu.
- Q: The Color image is distorted by dark shadows.
- A: Adjust the **Color Control** option in the OSD adjustment menu.
- Q: The Color white is poor.
- A: Adjust the **Color Control** option in the OSD adjustment menu.
- Q: The Power Indicator blinks.
- A: The LCD Display is currently saving the changes made in the settings to the OSD memory.
- Q: The screen is blank and the power indicator light blinks every 0.5 or 1 seconds.
- A: The LCD Display is using its power management system. Press any key on the keyboard.

Problems related to Audio



Problems related to audio signals and their solutions are listed below.

- Q: No sound.
- A: Ensure that the audio cable is firmly connected to both the audio-in port on your LCD Display and the audio-out port on your sound card.
- (Refer to the Connecting a Computer)
- A: Check the volume level.
- Q: The sound level is too low.
- A: Check the volume level.
- A: If the volume is still too low after turning the control to its maximum, check the volume control on the computer sound card or software Program.
- Q: The sound is too high or too low.
- A: Adjusts the **Treble** and **Bass** to the appropriate levels.

Problems related to the Remote Control



Problems related to the remote control and their solutions are listed.

- Q: The remote control buttons do not respond.
- A: Check the polarities (+/-) of the batteries.
- A: Check if the batteries are empty.
- A: Check if the power is on.
- A: Check if the power cord is securely connected.
-

A: Check if a special fluorescent or neon lamp is on in the vicinity.

Q & A

Q: How can I change the frequency?

A: The frequency can be changed by reconfiguring the video card.



That video card support can vary, depending on the version of the driver used. (Refer to the computer or the video card manual for details.)

Q: How can I adjust the resolution?

A: Windows XP:

Set the resolution in the Control Panel → Appearance and Themes → Display → Settings.

A: Windows ME/2000:

Set the resolution in the Control Panel → Display → Settings.

* Contact the video card manufacturer for details.

Q: How can I set the Power Saving function?

A: Windows XP:

Control Panel → Appearance and Themes → Display → Enable the powersaving feature in Screen Saver.

Set the function in the BIOS-SETUP of the computer. (Refer to the Windows / Computer Manual).

A: Windows ME/2000:

Control Panel → Display → Screen Saver.

Set the function in the BIOS-SETUP of the computer. (Refer to the Windows / Computer Manual).

Q: How can I clean the outer case/LCD Panel?

A: Disconnect the power cord and then clean the LCD Display with a soft cloth, using either a cleaning solution or plain water.

Do not leave any detergent or scratches on the case. Do not let any water enter the LCD Display.



Before calling for assistance, check the information in this section to see if you can remedy any problems yourself. If you do need assistance, please call the phone number on the Information section or contact your dealer.

Specifications

General

General

Model Name	400MX-3 , 460MX-3, 400FP-3, 460FP-3
------------	-------------------------------------

LCD Panel

Size	400MX-3, 400FP-3	40.0 inch / 101 cm
	460MX-3, 460FP-3	46.0 inch / 116 cm
Display Area	400MX-3, 400FP-3	885.6 mm(H) x 498.15 mm (V)
	460MX-3, 460FP-3	1018.08 mm(H) x 572.67 mm(V)

Synchronization

Horizontal	30~81 kHz
------------	-----------

Vertical	56~85 Hz
----------	----------

Display Color

16.7M (true)

Resolution

Optimum resolution	1920 x 1080 @ 60 Hz
--------------------	---------------------

Maximum resolution	1920 x 1080 @ 60 Hz
--------------------	---------------------

Maximum Pixel Clock

148.5MHz (Analog, Digital)

Power Supply

This product supports 100 - 240 V.

Since the standard voltage may differ from country to country, please check the label on the back of the product.

Signal connectors

D-sub(Component), DVI-D In, VCR, HDMI 1/2, RS232C In/Out, DP, DC Out, Stereo Audio In/Out, Audio In(L/R), RJ45, (RS232C, USB, LAN, D-sub out, HDMI out, Audio out → Slide in Network Box)

Dimensions (W x H x D) / Weight

400MX-3, 400FP-3	971.0 mm x 641.5 mm x 311.0 mm / 38.2 x 25.3 x 12.2 inches (With Stand)
------------------	---

971.0 mm x 582.0 mm x 119.0 mm / 38.2 x 22.9 x 4.7 inches (Without Stand)

21.6 Kg / 47.6 lbs (With Network Box)

19.3 Kg / 42.5 lbs (Without Network Box)
--

Dimensions (W x H x D) / Weight

460MX-3, 460FP-3	1102.0 mm x 719.0 mm x 311.0 mm / 43.4 x 28.3 x 12.2 inches (With Stand)
	1102.0 mm x 658.0 mm x 125.5 mm / 43.4 x 25.9 x 4.9 inches (Without Stand)
	25.1 Kg / 47.4 lbs (With Network Box)
	22.8 Kg / 50.3 lbs (Without Network Box)

VESA Mounting Interface

600.0 mm x 400.0 mm

Environmental considerations

Operating (With Network Box) Temperature : 50°F ~ 104°F (10°C ~ 40°C)
Humidity : 10 % ~ 80 %, non-condensing

Operating (Without Network Box) Temperature : 32°F ~ 104°F (0°C ~ 40°C)
Humidity : 10 % ~ 80 %, non-condensing

Storage Temperature : -4°F ~ 113°F (-20°C ~ 45°C)
Humidity : 5 % ~ 95 %, non-condensing

Plug and Play Capability

This LCD Display can be installed on any Plug & Play compatible system. The interaction of the LCD Display and the computer systems will provide the best operating conditions and LCD Display settings. In most cases, the LCD Display installation will proceed automatically, unless the user wishes to select alternate settings.

Dot Acceptable

TFT-LCD panels manufactured by using advanced semiconductor technology with precision of 1ppm (one millionth) above are used for this product. But the pixels of RED, GREEN, BLUE and WHITE Color appear to be bright sometimes or some black pixels may be seen. This is not from bad quality and you can use it without any problems.

For example, the number of TFT-LCD sub pixels contained in this product are 6,220,800.

Note

Design and specifications are subject to change without prior notice.

When the network box is connected

Class A (Information Communication equipment for industrial use)

Attention dealers and users. This device is registered for EMC requirements for industrial use (Class A) and can be used in areas other than general households.

When the network box is not connected

Class B (Information Communication equipment for residential use)

This device is registered for EMC requirements for home use (Class B). It can be used in all areas. (Class B equipment emits less electromagnetic waves than Class A equipment.)

(USA only)

Dispose unwanted electronics through an approved recycler.

To find the nearest recycling location, go to our website:
www.samsung.com/recyclingdirect Or call, (877) 278 - 0799

PowerSaver

This LCD Display has a built-in power management system called PowerSaver. This system saves energy by switching your LCD Display to low-power mode when it has not been used for a certain amount of time. The LCD Display automatically returns to normal operation when you press a key on the keyboard. For energy conservation, turn your LCD Display OFF when it is not needed, or when leaving it unattended for long periods. The PowerSaver system operates with a VESA DPM compliant video card installed in your computer. Use the software utility installed on your computer to set up this feature.

PowerSaverd

State	Normal Op- eration	Power sav- ing mode	Power off	Power off (Power Swich)	
Power Indicator	On	Blinking	Amber	Off	
Power Con- sumption (Typical)	400MX-3, 400FP-3	250 Watts	5 Watts	5 Watts	0 Watts
	(With Net- work Box)				
	400MX-3, 400FP-3	193 Watts	2 Watts	1 Watts	0 Watts
	(Without Network Box)				
	460MX-3, 460FP-3	313 Watts	5 Watts	5 Watts	0 Watts
	(With Net- work Box)				
	460MX-3, 460FP-3	233 Watts	2 Watts	1 Watts	0 Watts
	(Without Network Box)				

 **Note**

- The actual power consumption may be different from the indicated power consumption above if the system conditions or settings are changed.

- To stop any power consumption, turn off the switch or disconnect the power cable on the back. Be sure to disconnect the power if you intend to stay away from home for many hours.
- If you connect a network box (sold separately), the product will no longer be in compliance with Energy Star 5.0 specifications.

Preset Timing Modes

If the signal transferred from the computer is the same as the following Preset Timing Modes, the screen will be adjusted automatically. However, if the signal differs, the screen may go blank while the power LED is on. Refer to the video card manual and adjust the screen as follows.

Display Mode	Horizontal Frequency (kHz)	Vertical Frequency (Hz)	Pixel Clock (MHz)	Sync Polarity (H/V)
IBM, 640 x 350	31.469	70.086	25.175	+/-
IBM, 640 x 480	31.469	59.940	25.175	-/-
IBM, 720 x 400	31.469	70.087	28.322	-/+
MAC, 640 x 480	35.000	66.667	30.240	-/-
MAC, 832 x 624	49.726	74.551	57.284	-/-
MAC, 1152 x 870	68.681	75.062	100.000	-/-
VESA, 640 x 480	37.861	72.809	31.500	-/-
VESA, 640 x 480	37.500	75.000	31.500	-/-
VESA, 800 x 600	35.156	56.250	36.000	+/+
VESA, 800 x 600	37.879	60.317	40.000	+/+
VESA, 800 x 600	48.077	72.188	50.000	+/+
VESA, 800 x 600	46.875	75.000	49.500	+/+
VESA, 848 x 480	31.020	60.000	33.750	+/+
VESA, 1024 x 768	48.363	60.004	65.000	-/-
VESA, 1024 x 768	56.476	70.069	75.000	-/-
VESA, 1024 x 768	60.023	75.029	78.750	+/+
VESA, 1152 x 864	67.500	75.000	108.000	+/+
VESA, 1280 x 768	47.776	59.870	79.500	-/+
VESA, 1280 x 960	60.000	60.000	108.000	+/+
VESA, 1280 x 1024	63.981	60.020	108.000	+/+
VESA, 1280 x 1024	79.976	75.025	135.000	+/+
VESA, 1360 x 768	47.712	60.015	85.500	+/+
VESA, 1366 x 768	47.712	59.790	85.500	+/+
VESA, 1920 x 1080	66.587	59.934	138.500	+/-
VESA, 1920 x 1080	67.500	60.000	148.500	+/+



Horizontal Frequency

The time to scan one line connecting the right edge to the left edge of the screen horizontally is called the Horizontal Cycle and the inverse number of the Hor-

Specifications

Horizontal Cycle is called the Horizontal Frequency.
Unit: kHz

Vertical Frequency

Like a fluorescent lamp, the screen has to repeat the same image many times per second to display an image to the user. The frequency of this repetition is called the Vertical Frequency or Refresh Rate. Unit: Hz

Information

For a Better Display

➤ Adjust the computer resolution and screen injection rate (refresh rate) on the computer as described below to enjoy the best picture quality. You can have an uneven picture quality on screen if the best picture quality is not provided for TFT-LCD.

- Resolution: 1920 x 1080
- Vertical frequency (refresh rate): 60 Hz

➤ TFT-LCD panels manufactured by using advanced semiconductor technology with a precision of 1ppm (one millionth) and above is used for this product. But the pixels of RED, GREEN, BLUE and WHITE Color seem to be bright sometimes or some of black pixels could be seen. This is not from bad quality and you can use it without any problems.

- For example, the number of TFT-LCD sub pixels contained in this product are 6,220,800.

➤ When cleaning the monitor and the panel outside, please apply a small amount of water to a soft cloth. Rub softly when cleaning the LCD area. If excessive force is applied, you may stain it.

➤ If you are not satisfied with the picture quality, you can get better quality of picture by performing the "**Auto Adjustment**" function in display screen that is appeared as window termination button is pressed. If there's still noise after the automatic adjustment, use the **Fine/Coarse** adjustment function.

➤ When viewing a fixed screen for an extended period of time, a residual image or blurriness may appear. Change the mode to energy save or set a screensaver to move the picture when you need to be away from the monitor for an extended period of time.

PRODUCT INFORMATION (Image Retention Free)

➤ *What is Image Retention ?*

Image retention may not occur when a LCD panel is operated under normal conditions.

Normal conditions are defined as continuously changing video patterns. When the LCD panel is operated for a long time with a fixed pattern (over 12 hours), there may be slight difference in voltage between electrodes that work the liquid crystal (LC) in a pixel. The voltage difference between electrodes increases with time, forcing the liquid crystal to lean. When this occurs, the previous image may be seen when the pattern is changed. To prevent this, the accumulated voltage difference must be decreased.

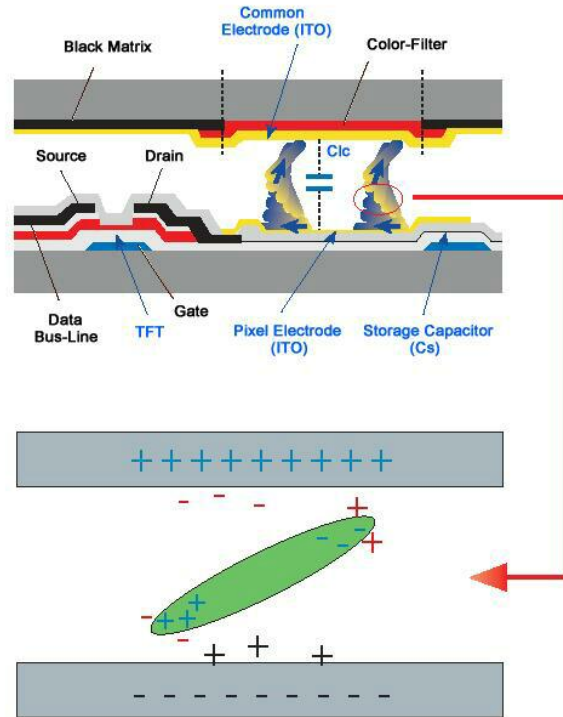

+ *Power Off, Screen Saver, or Power Save Mode*

- Turn the power off for 2 hours after 12 hours in use
- Set the Monitor to power off with the PC Display Properties Power Scheme.
- Use a Screen saver if possible - Screen saver in one Color or a moving image is recommended.
- The Image Retention Free function applied to the product is recommended.

+ *Change the Color Information periodically*

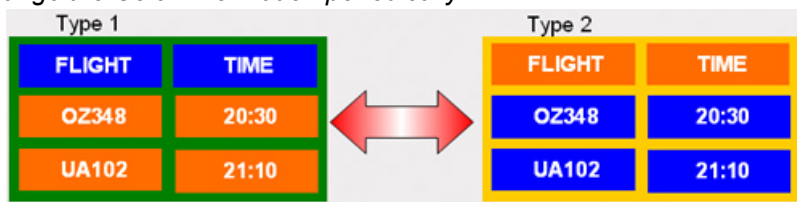

Note

Use Two different Colors

Rotate the Color Information with 2 different Colors every 30 minutes.

- Avoid using a combination of characters and background Color with large difference in luminance.

Avoid using Grey Colors, which can cause Image retention easily.

Avoid: Colors with big difference in luminance (Black & White, Grey)

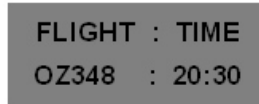

⊕ *Change the characters Color periodically*

- Use Bright Colors with little difference in luminance.
 - Cycle : Change the characters Color and background Color every 30 minutes

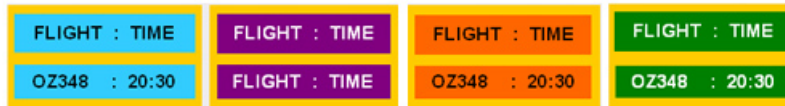

- Every 30 minutes, change the characters with movement.



- Have the images and logo cycle periodically.
 - Cycle: Display moving image together with Logo for 60 seconds after 4 hours in use.
- The best way to protect your monitor from Image retention is to turn the Power off, or set your PC or System to operate a Screen Saver Program when you are not using it. If these guidelines are not followed, it may affect your warranty.

⊕ *Apply the Screen Pixel function on Product*

- Apply the Screen Pixel function
 - Symptom: Dot with Black Color move up and down.



- Apply the Screen Bar function
 - Symptom: Horizontal / Vertical Bar with Black Color move up and down.



⊕ *Apply the Screen Erasing function on Product*

- Apply the Screen Erasing function
 - Symptom: 2 Vertical blocks move while erasing the display

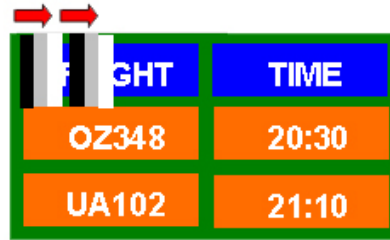

Appendix

Contact SAMSUNG WORLDWIDE



If you have any questions or comments relating to Samsung products, please contact the SAMSUNG customer care center.

North America

U.S.A	1-800-SAMSUNG (726-7864)	http://www.samsung.com
CANADA	1-800-SAMSUNG (726-7864)	http://www.samsung.com/ca http://www.samsung.com/ca_fr (French)
MEXICO	01-800-SAMSUNG (726-7864)	http://www.samsung.com

Latin America

ARGENTINA	0800-333-3733	http://www.samsung.com
BRAZIL	0800-124-421 4004-0000	http://www.samsung.com
BOLIVIA	800-10-7260	http://www.samsung.com
CHILE	800-SAMSUNG (726-7864) From mobile 02-482 82 00	http://www.samsung.com
COLOMBIA	01-8000112112	http://www.samsung.com
COSTA RICA	0-800-507-7267	http://www.samsung.com
DOMINICA	1-800-751-2676	http://www.samsung.com
ECUADOR	1-800-10-7267	http://www.samsung.com
EL SALVADOR	800-6225	http://www.samsung.com
GUATEMALA	1-800-299-0013	http://www.samsung.com
HONDURAS	800-27919267	http://www.samsung.com
JAMAICA	1-800-234-7267	http://www.samsung.com
NICARAGUA	00-1800-5077267	http://www.samsung.com
PANAMA	800-7267	http://www.samsung.com
PERU	0-800-777-08	http://www.samsung.com
PUERTO RICO	1-800-682-3180	http://www.samsung.com
TRINIDAD & TOBAGO	1-800-SAMSUNG (726-7864)	http://www.samsung.com
VENEZUELA	0-800-100-5303	http://www.samsung.com

Europe

ALBANIA	42 27 5755	http://www.samsung.com
AUSTRIA	0810 - SAMSUNG (7267864, € 0.07/min)	http://www.samsung.com
BELGIUM	02-201-24-18	http://www.samsung.com/be (Dutch)

Appendix

Europe

		http://www.samsung.com/be_fr (French)
BOSNIA	05 133 1999	http://www.samsung.com
BULGARIA	07001 33 11	http://www.samsung.com
CROATIA	062 SAMSUNG (062 726 7864)	http://www.samsung.com
CZECH	800 - SAMSUNG (800-726786)	http://www.samsung.com
	Samsung Electronics Czech and Slovak, s.r.o., Oasis Florenc, Sokolovská 394/17, 180 00, Praha 8	
DENMARK	70 70 19 70	http://www.samsung.com
FINLAND	030 - 6227 515	http://www.samsung.com
FRANCE	01 48 63 00 00	http://www.samsung.com
GERMANY	01805 - SAMSUNG (726-7864, € 0,14/Min)	http://www.samsung.com
CYPRUS	From landline : 8009 4000	http://www.samsung.com
GREECE	From landline : 80111-SAMSUNG (7267864)	http://www.samsung.com
	From landline & mobile : (+30) 210 6897691	
HUNGARY	06-80-SAMSUNG (726-7864)	http://www.samsung.com
ITALIA	800-SAMSUNG (726-7864)	http://www.samsung.com
KOSOVO	+381 0113216899	http://www.samsung.com
LUXEMBURG	261 03 710	http://www.samsung.com
MACEDONIA	023 207 777	http://www.samsung.com
MONTENEGRO	020 405 888	http://www.samsung.com
NETHERLANDS	0900-SAMSUNG (0900-7267864) (€ 0,10/Min)	http://www.samsung.com
NORWAY	815-56 480	http://www.samsung.com
POLAND	0 801-1SAMSUNG(172-678)	http://www.samsung.com
	+48 22 607-93-33	
PORTUGAL	808 20-SAMSUNG (808 20 7267)	http://www.samsung.com
RUMANIA	From landline : 08010-SAMSUNG (7267864)	http://www.samsung.com
	From landline & mobile : (+40) 21 206 01 10	
SERBIA	0700 SAMSUNG (0700 726 7864)	http://www.samsung.com
SLOVAKIA	0800 - SAMSUNG (0800-726 786)	http://www.samsung.com
SPAIN	902 - 1 - SAMSUNG (902 172 678)	http://www.samsung.com
SWEDEN	0771 726 7864 (SAMSUNG)	http://www.samsung.com

Appendix

Europe

SWITZERLAND	0848 - SAMSUNG (7267864, CHF 0.08/min)	http://www.samsung.com/ch_fr/ (French)
U.K	0330 SAMSUNG (7267864)	http://www.samsung.com
EIRE	0818 717100	http://www.samsung.com
LITHUANIA	8-800-77777	http://www.samsung.com
LATVIA	8000-7267	http://www.samsung.com
ESTONIA	800-7267	http://www.samsung.com
TURKEY	444 77 11	http://www.samsung.com

CIS

RUSSIA	8-800-555-55-55	http://www.samsung.com
GEORGIA	8-800-555-555	http://www.samsung.com
ARMENIA	0-800-05-555	http://www.samsung.com
AZERBAIJAN	088-55-55-555	http://www.samsung.com
KAZAKHSTAN	8-10-800-500-55-500 (GSM: 7799)	http://www.samsung.com
UZBEKISTAN	8-10-800-500-55-500	http://www.samsung.com
KYRGYZSTAN	00-800-500-55-500	http://www.samsung.com
TADJIKISTAN	8-10-800-500-55-500	http://www.samsung.com
MONGOLIA	-	http://www.samsung.com
UKRAINE	0-800-502-000	http://www.samsung.com/ua
		http://www.samsung.com/ua_ru
BELARUS	810-800-500-55-500	http://www.samsung.com
MOLDOVA	00-800-500-55-500	http://www.samsung.com

Asia Pacific

AUSTRALIA	1300 362 603	http://www.samsung.com
NEW ZEALAND	0800 SAMSUNG (0800 726 786)	http://www.samsung.com
CHINA	400-810-5858	http://www.samsung.com
HONG KONG	(852) 3698 - 4698	http://www.samsung.com/hk_en/
INDIA	1800 1100 11 3030 8282 1800 3000 8282 1800 266 8282	http://www.samsung.com
INDONESIA	0800-112-8888 021-5699-7777	http://www.samsung.com

Asia Pacific

JAPAN	0120-327-527	http://www.samsung.com
MALAYSIA	1800-88-9999	http://www.samsung.com
PHILIPPINES	1-800-10-SAMSUNG (726-7864) for PLDT	http://www.samsung.com
	1-800-3-SAMSUNG (726-7864) for Digitel	
	1-800-8-SAMSUNG (726-7864) for Globe	
	02-5805777	
SINGAPORE	1800-SAMSUNG (726-7864)	http://www.samsung.com
THAILAND	1800-29-3232	http://www.samsung.com
	02-689-3232	
TAIWAN	0800-329-999	http://www.samsung.com
	0266-026-066	
VIETNAM	1 800 588 889	http://www.samsung.com

Middle East

IRAN	021-8255	http://www.samsung.com
OMAN	800-SAMSUNG (726-7864)	http://www.samsung.com
KUWAIT	183-2255	http://www.samsung.com
BAHRAIN	8000-4726	http://www.samsung.com
EGYPT	08000-726786	http://www.samsung.com
JORDAN	800-22273	http://www.samsung.com
MOROCCO	080 100 2255	http://www.samsung.com
SAUDI ARABIA	9200-21230	http://www.samsung.com
U.A.E	800-SAMSUNG (726-7864)	http://www.samsung.com

Africa

CAMEROON	7095- 0077	http://www.samsung.com
COTE D'IVOIRE	8000 0077	http://www.samsung.com
GHANA	0800-10077	http://www.samsung.com
	0302-200077	
KENYA	0800 724 000	http://www.samsung.com
NIGERIA	0800-726-7864	http://www.samsung.com
SENEGAL	800-00-0077	http://www.samsung.com
SOUTH AFRICA	0860-SAMSUNG (726-7864)	http://www.samsung.com
TANZANIA	0685 88 99 00	http://www.samsung.com
UGANDA	0800 300 300	http://www.samsung.com

Terms

Dot Pitch

The image on a monitor is composed of red, green and blue dots. The closer the dots, the higher the resolution. The dis-

	<p>tance between two dots of the same Color is called the 'Dot Pitch'. Unit: mm</p>
Vertical Frequency	<p>The screen must be redrawn several times per second in order to create and display an image for the user. The frequency of this repetition per second is called the Vertical Frequency or Refresh Rate. Unit: Hz</p> <p>Example: If the same light repeats itself 60 times per second, this is regarded as 60 Hz.</p>
Horizontal Frequency	<p>The time to scan one line connecting the right edge to the left edge of the screen horizontally is called the Horizontal Cycle. The inverse number of the Horizontal Cycle is called Horizontal Frequency. Unit: kHz</p>
Interlace and Non-Interlace Methods	<p>Showing the horizontal lines of the screen from the top to the bottom sequentially is called the Non-Interlace method while showing odd lines and then even lines in turn is called the Interlace method. The Non-Interlace method is used for the majority of monitors to ensure a clear image. The Interlace method is the same as that used in TVs.</p>
Plug & Play	<p>This is a function that provides the best quality screen for the user by allowing the computer and the monitor to exchange information automatically. This monitor follows the international standard VESA DDC for the Plug & Play function.</p>
Resolution	<p>The number of horizontal and vertical dots used to compose the screen image is called the 'resolution'. This number shows the accuracy of the display. A high resolution is good for performing multiple tasks as more image information can be shown on the screen.</p> <p>Example: If the resolution is 1920 x 1080, this means the screen is composed of 1920 horizontal dots (horizontal resolution) and 1080 vertical lines (vertical resolution).</p>

Correct Disposal

Correct Disposal of This Product (Waste Electrical & Electronic Equipment)



(Applicable in the European Union and other European countries with separate collection systems)

This marking on the product, accessories or literature indicates that the product and its electronic accessories (e.g. charger, headset, USB cable) should not be disposed of with other household waste at the end of their working life. To prevent possible harm to the environment or human health from uncontrolled waste disposal, please separate these items from other types of waste and recycle them responsibly to promote the sustainable reuse of material resources.

Household users should contact either the retailer where they purchased this product, or their local government office, for details of where and how they can take these items for environmentally safe recycling.

Business users should contact their supplier and check the terms and conditions of the purchase contract. This product and its electronic accessories should not be mixed with other commercial wastes for disposal.

Correct disposal of batteries in this product



(Applicable in the European Union and other European countries with separate battery return systems.)

This marking on the battery, manual or packaging indicates that the batteries in this product should not be disposed of with other household waste at the end of their working life. Where marked, the chemical symbols Hg, Cd or Pb indicate that the battery contains mercury, cadmium or lead above the reference levels in EC Directive 2006/66. If batteries are not properly disposed of, these substances can cause harm to human health or the environment.

To protect natural resources and to promote material reuse, please separate batteries from other types of waste and recycle them through your local, free battery return system.



Note

The rechargeable battery incorporated in this product is not user replaceable. For information on its replacement, please contact your service provider.

Authority



Information in this document is subject to change without notice.

© 2010 Samsung Electronics Co., Ltd. All rights reserved.

Reproduction in any manner whatsoever without the written permission of Samsung Electronics Co., Ltd. is strictly forbidden.

Samsung Electronics Co., Ltd. shall not be liable for errors contained herein or for incidental or consequential damages in connection with the furnishing, performance, or use of this material.

Samsung is the registered trademark of Samsung Electronics Co., Ltd.; Microsoft, Windows and Windows NT are registered trademarks of Microsoft Corporation; VESA, DPM and DDC are registered trademarks of Video Electronics Standard Association; All other product names mentioned herein may be the trademarks or registered trademarks of their respective owners.

 TruSurround XT	TruSurround XT, SRS and the  symbol are trademarks of SRS Labs, Inc. TruSurround XT technology is incorporated under license from SRS Labs, Inc.
---	--